

Hydraulic Impacts of Quarries and Gravel Pits



Prepared by

J.A. Green, J.A. Pavlish, R.G. Merritt, and J.L. Leete
Minnesota Department of Natural Resources,
Division of Waters

for the

Legislative Commission on Minnesota Resources

funded by the

Minnesota Environment and Natural Resources Trust Fund

2005

Hydraulic Impacts of Quarries and Gravel Pits

Executive Summary



EXECUTIVE SUMMARY

Natural aggregate (crushed stone, sand, and gravel) is a vital part of our economic infrastructure in Minnesota. Aggregate is used for road and bridge construction and in a variety of building materials. In 2003, the value of construction sand and gravel and crushed stone in Minnesota was approximately \$245,000,000. As Minnesota's economy continues to expand, the demand for aggregate will continue to grow. Sand and gravel pits are located in every county in Minnesota. In 1990, the Minnesota Department of Natural Resources, Division of Minerals (DNR Minerals), estimated the number of active and inactive operations at 1500 with the view that this number was likely too low (Dennis Martin, pers. comm.). Quarries for mining limestone, dolomite, sandstone, and hard rock (granite and quartzite) are found in 34 counties. A 1990 DNR Minerals inventory found 165 active operations, 88% of which were limestone quarries (Nelson and others, 1990). That same inventory counted 1,367 inactive operations, 70% of which were limestone quarries.

Aggregate mining is an extractive use of resources: mining alters the landscape and its natural hydrologic system. When a new pit or quarry is proposed or when an existing operation needs to expand, local governments and citizens typically have many questions about the impacts mining might have. Local governments, which are responsible for reviewing these operations, rarely have the budgets to hire experts to evaluate potential impacts of quarry and gravel pit proposals. The Minnesota Legislature's Aggregate Resources Task Force identified that local government units (LGUs) often lack the expertise to assess ground-water models (Southwick and others, 2000).

Quarries and pits can affect ground-water and surface-water systems in various ways. This project focused on the following potential impacts:

- lowering of local ground-water and surface-water levels from mining operations and mine dewatering,
- changes in turbidity levels in ground water due to blasting and quarry operations,
- interruption of ground-water conduit flow paths by rock removal, and
- temperature change (thermal impacts) in springs and surface-water streams.

This report is intended to help local officials, the public, and the mining industry understand the main issues surrounding mine establishment and to provide suggestions for monitoring and mitigation strategies to prevent significant impacts on water resource. The research at these sites (Figure 1) provides the first comprehensive assessment of aggregate mining impacts on ground-water systems in Minnesota. This information can be used for siting of new aggregate mines and for more accurately assessing their impacts on local ground-water resources. It can also be used for planning purposes at the state and local level.

Project Site Map

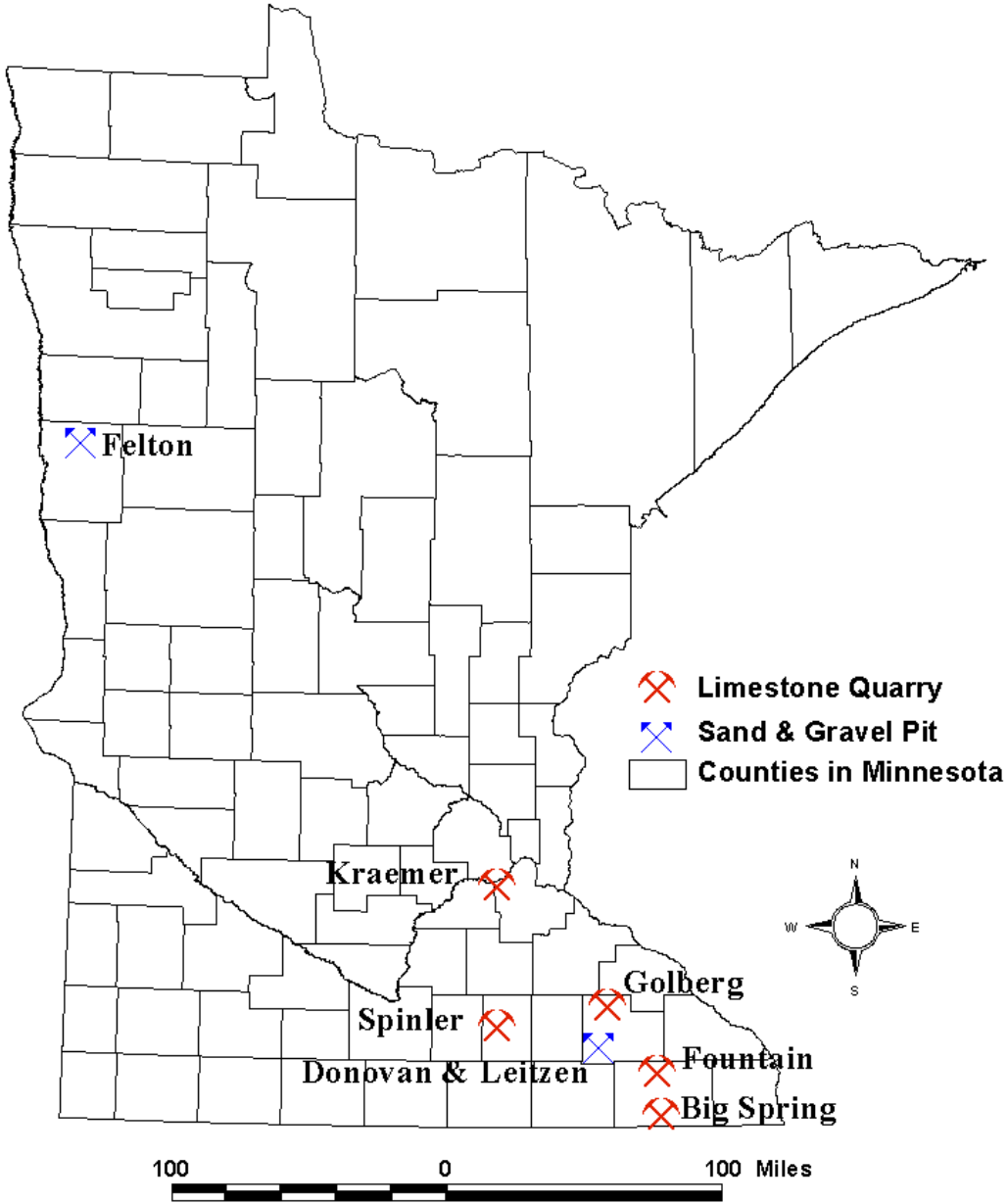

Figure 1. Site map.

Results and Conclusions

Table 1 lists the sites and the impacts that were studied during the project. The text following the table describes the results of the monitoring at the sites.

Summary of Impacts and Study Results		
Site	Impacts studied	Study results
Kraemer Quarry	Water level	Significant decline in aquifer water levels due to quarry dewatering and rock removal.
	Turbidity and well construction	No impacts observed.
Golberg Quarry	Water level	Significant decline in aquifer water levels due to quarry dewatering and rock removal.
	Turbidity and well construction	No impacts observed.
Spinler Quarry	Water level	Hydraulic gradient between the upper and lower aquifers has been reversed; the Straight River has been changed from a gaining to a losing stream.
Fountain Quarry	Turbidity	Blasting caused a slight increase in spring turbidity levels.
Big Spring Quarry	Spring diversion	Ground water that previously discharged directly at the Big Spring now discharges in the quarry. Some of it sinks and emerges at the Big Spring; the rest flows overland to Camp Creek.
	Temperature change	Significant temperature increases were noted in a summer measurement. Monitoring is continuing.
Donovan Pit	Water level	Mining had minimal impact on aquifer water levels.
	Temperature change	Ground-water temperature changes were noted but were not consistent. Monitoring is continuing.
Leitzen-Grabau Pit	Water level	Mining had minimal impact on aquifer water levels.
Felton Pit	Water level	Mining has altered ground-water flow paths affecting the water supply to a calcareous fen.

Table 1. Summary table of sites and impacts studied.

Limestone Quarries

Limestone quarries are found in southeastern Minnesota from the Twin Cities south to Iowa and west to Mankato. Some of these operations mine below the water table. In order to do this, the

quarries must be dewatered. Dewatering can locally depress the water table, altering ground-water flow paths and affecting nearby wells, springs, and surface-water bodies. Concerns have also been raised to DNR Waters and local government staff about the impacts of quarry blasting on domestic wells.

To investigate these issues, three sites were studied: the Kraemer quarry in Dakota County, the Golberg quarry at Rochester, and the Spinler quarry in Steele County southwest of Owatonna. Monitoring wells at these sites were equipped with automatic water level and turbidity monitoring devices.

Water-Level Impacts. At all three sites, the quarry dewatering has altered the local ground-water hydrology. In essence, the quarries act as huge wells, lowering the water table in the aquifer. The impact of the dewatering at the Kraemer Quarry is shown in Figure 2. This lowering could affect

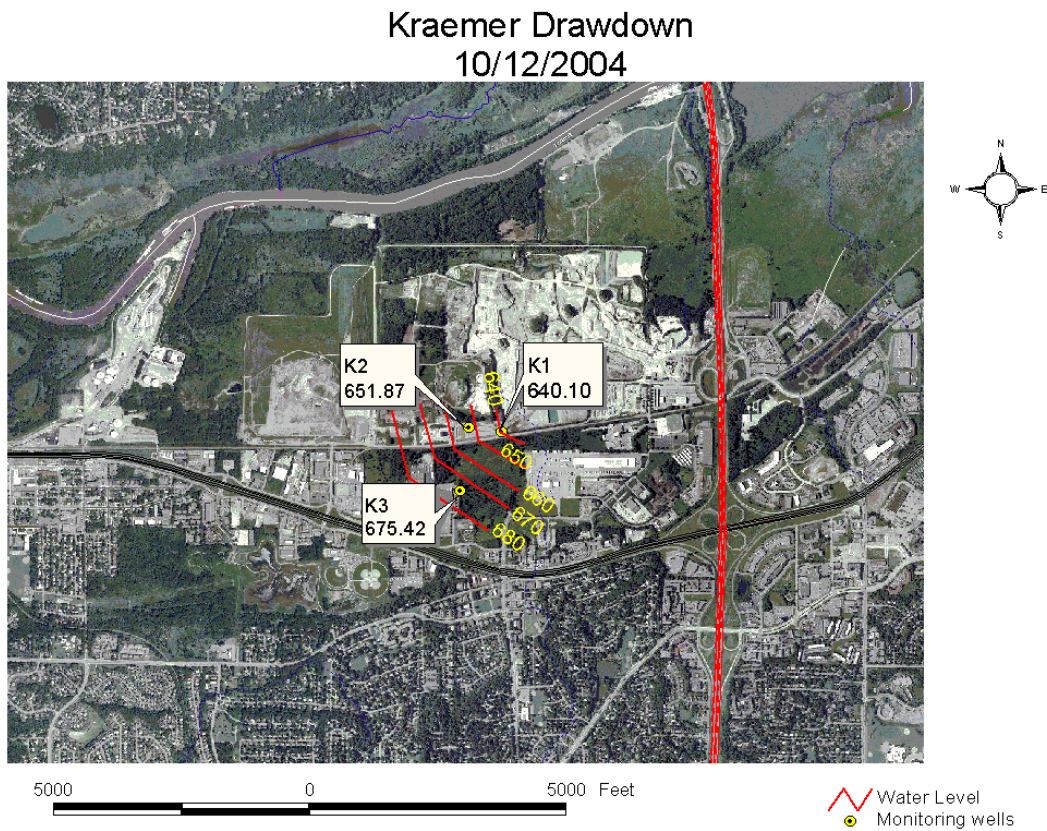

Figure 2. The impacts on ground-water levels of drawdown at Kraemer Quarry.

neighboring wells and testifies to the need for careful evaluation of quarry dewatering proposals and long-term monitoring of the dewatering impacts on the local aquifer. To further evaluate conditions at the Spinler quarry, a three-dimensional model was used. With the quarry being dewatered continuously, the quarry is now draining a confined limestone aquifer and a surficial sand and gravel aquifer. Model results also indicate that the Straight River, adjacent to the property, was probably a gaining stream before quarrying began and is now losing flow to the quarry.

Turbidity Impacts. Turbidity monitoring in the wells at these sites showed no impact from blasting. One of the tools purchased for this project, a downhole camera (a camera designed to video the inside of water wells) was used to inspect the wells. The camera allowed staff to visually inspect the condition of well casings. No damage from blasting or quarrying operations was visible in any of the wells, including those within 20 ft to 200 ft of the quarry face. The wells will be checked again in several years to determine whether continuing quarry operations have had an impact as the wells age.

The Fountain quarry at Fountain in Fillmore County is a dry quarry (quarrying operations are above the water table) that has been shown by dye tracing to be hydraulically connected to a nearby spring. Project staff monitored this spring for blasting and quarrying impacts on spring turbidity. This setting was chosen by staff to be analogous to the numerous older wells in southeastern Minnesota that are finished in the surficial limestone deposits that are being quarried. Typically, citizens with these wells are those who complain about quarrying impacts on their wells. The monitoring showed slight increases in turbidity after blasting (Figure 3). Based on known ground-water travel times, this material had to be present in the limestone’s conduits (enlarged joints) prior to the blast. The blasting shook the limestone and the ground water and released some sediment. In an older well finished in the surface limestone deposit, this mechanism could cause turbidity levels to increase after a blast.

Fountain Big Spring Turbidity

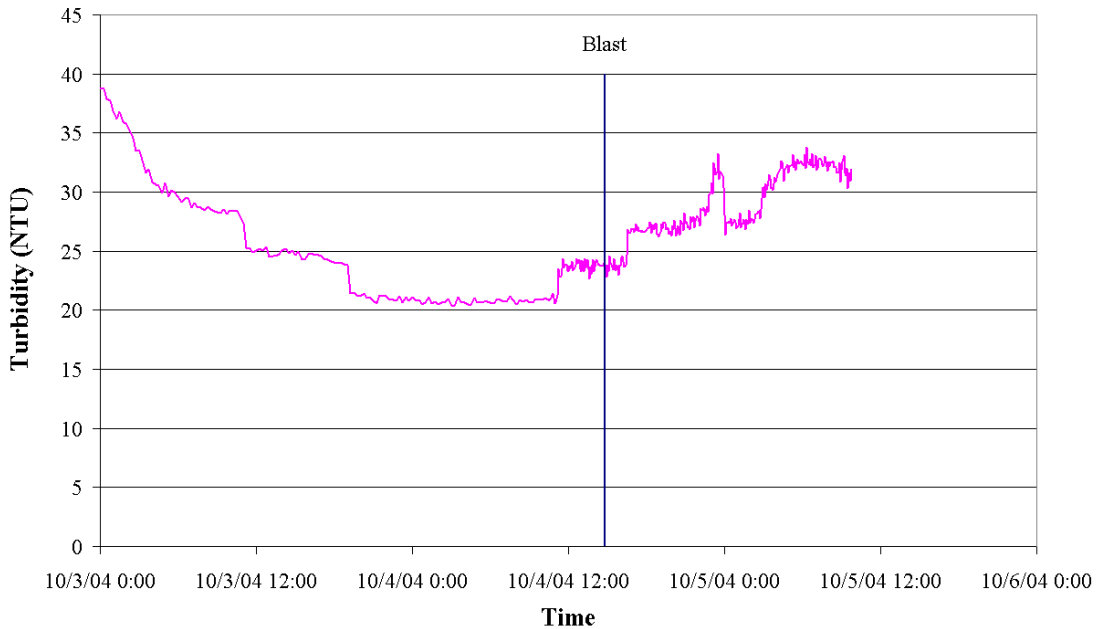

Figure 3. Monitoring showed slight turbidity increases after blasting at Fountain.

The disruption of ground-water conduit flow paths by rock removal was studied at the Big Spring quarry at Harmony in Fillmore County; quarrying operations penetrated the conduit system more than 40 years ago. Ground water that formerly discharged at the Big Spring on Camp Creek now discharges in the quarry. This water either sinks back into the limestone to re-emerge at the Big Spring or flows overland to Camp Creek. Dye tracing demonstrated that approximately 90% of

the ground-water basin is now being routed through the quarry. Without any dewatering occurring, this quarry has altered ground-water flow paths. This water is more vulnerable to quarrying operations. Temperature measurements indicate that the Big Spring was 8 degrees Fahrenheit warmer (July measurement) than the water that first discharges in the quarry, and the stream flowing out of the quarry to Camp Creek was 17 degrees warmer (Figure 4). Temperature changes of this magnitude could have a negative effect on fish populations in Camp Creek, a designated trout stream.

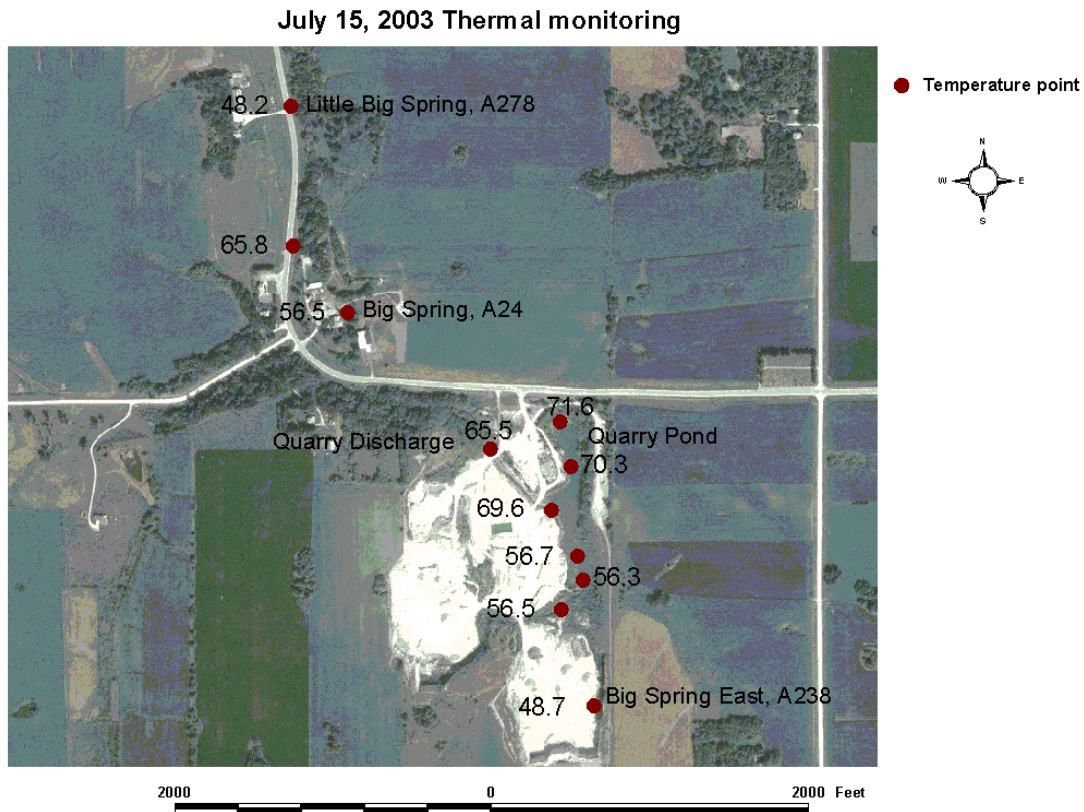

Figure 4. Temperature monitoring of water at Big Spring Quarry in Harmony.

Sand and Gravel Pits

Impacts on Ground-Water Levels and Flow Direction. Sand and gravel pits are typically located in alluvial floodplains along streams and in glacial deposits. The sites studied for this project are shown in Figure 1 above.

Two alluvial sand and gravel pits, Donovan pit and the Leitzen-Grabau pit, along the Zumbro River in Olmsted County were studied. The Leitzen-Grabau pit was only a few feet below the water table at its highest point after heavy rains or snowmelt. The Donovan pit had a pond area created by mining that is 500 ft by 400 ft by 30 ft deep; in this area, sand and gravel was mined by dredging (Figure 5). Neither pit was dewatered. At both sites, there was no significant impact on ground-water levels from mining. The fluctuations that were seen in the monitoring wells were due to precipitation events (Figure 6). A common concern about these operations is their impact

on water levels in nearby sandpoint wells. Our results show that this type of mining should not affect the water level in these wells.



Figure 5. Donovan pit mining with a hydraulic dredge.

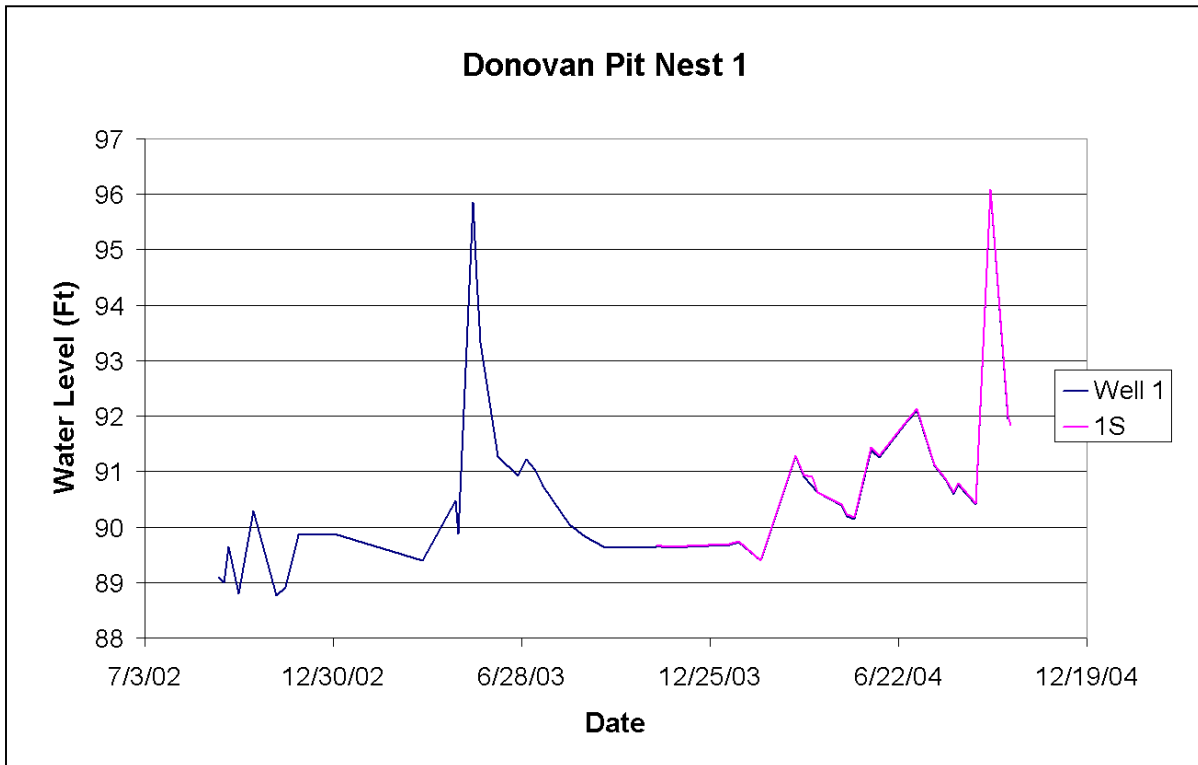

Figure 6. Water level measurements, well nest 1, Donovan Pit.

One sand and gravel site in a glacial deposit, Felton gravel pit, was studied for this project. The Felton pit is on a glacial lake beach ridge in Clay County. This operation mines sand and gravel with a dragline in an open pit below the water table. Although the pit is not dewatered, the mine has altered the ground-water flow direction in the sand and gravel deposit, which has affected a nearby calcareous fen (wetland with ground water for its water source). This type of wetland

needs to be identified prior to mining in order to site and plan mining operations in a manner that will not disrupt the water supply to fens.

Temperature Impacts. A second concern at alluvial sites is the impact open ponds could have on the temperature characteristics of the adjacent streams. These ponds change the thermal character of the ground water and could conceivably change temperatures in the streams adjacent to the pits. While some temperature monitoring was done for this project, its results were inconclusive primarily because of the intermittent schedule for taking temperature measurements. In order to increase the frequency of measurements and automate the process, temperature recorders (thermochrons) were purchased and deployed at the Donovan pit 1 month prior to the end of this project. This will allow monitoring to continue at the site for an extended time period. DNR staff conducted a dye trace through the sand and gravel to determine ground-water velocity in the deposit. Combined with the temperature data from the thermochrons, this information will be very useful for future thermal modeling.

Recommendations

Based on the results of this project, a list of recommendations was developed for local governments to use as they evaluate mining proposals. These recommendations are focused on what type of water-resource issues may be of concern and what information is needed from the mining company to address those concerns. Companies already obtain much of the needed information as they evaluate potential sites. The following information should be available to local units of government to help them evaluate quarry and pit proposals.

Topographic Map

One area of concern is the topography of a mining site. A map showing elevations, roads, floodplains, property lines, and other natural and human-made features should be provided. It can be used to address runoff, flooding, and equipment storage area questions.

Geologic Map

A geologic map of the site is an important piece of information that should be supplied by the mine operator. The information provided by a geologic map will provide answers to questions about the deposit's size and extent, geologic boundaries, clay or shale layers that are protecting lower aquifers, and the amount of unusable material that will need to be stockpiled and stored at the site.

Hydrologic Information

Assessing the potential impacts of mining operations on ground-water flow, wells, and surface waters requires hydrologic information. The direction of ground-water flow in the deposit, the location and construction of wells, and any surface-water bodies (streams, lakes, wetlands, and springs) should be displayed on a map of the area at the appropriate scale. If the mine is to be dewatered, the pumping point, volume, and discharge location should also be included. This information will allow local government staff and mining companies to assess the impact a quarry or pit will have on adjacent wells and surface-water features.

Karst Information

Limestone quarries have some particular information needs due to their potential to affect water resources that are not immediately adjacent to the site. An experienced karst hydrologist or geologist should conduct an inventory and survey of springs, sinkholes, stream sinks, caves, and other karst features in the area. Dye tracing may be needed to determine the connection between sinkholes and stream sinks at the site and area springs. Properly assessing the hydrology of a limestone area should aid in siting new quarries in locations where they will not affect springs and streams.

Mining Plan

To visualize the size and scope of mining operations, a detailed mining plan should be provided. It should include mining stages; dimensions of the mine; and the location of processing areas, stockpiles, settling ponds, washing facilities, stormwater ponds, and roads. This plan could be combined with the topographic map to present an overall view of the site and the mine operations.

Reclamation Plan

A key issue is the use and character of a mining area after mining operations end. To address this issue, a reclamation plan should be prepared. It needs to detail what reclamation activities will be done during mining, reclamation methods, vegetation types, shape and slope of open water areas, and the future use of the site. This information will allow local governments and the mining companies to tailor the reclamation plan so that the design and use of the reclaimed area is compatible with the surrounding properties.

Conclusions

Ultimately, aggregate mines can only be located in areas where there are aggregate resources. Our studies have shown that in certain areas, these mines can affect the local water resources. Quarries and pits that actively dewater may have impacts on neighboring wells. Mine operations and dewatering schedules may need to be altered to minimize impacts on streams and springs. Areas that may need to be avoided include those with calcareous fens and large springs.

A complete listing of the recommendations to local governments is found in the Outcomes sections in the main report. These recommendations, when implemented by local governments and followed by the mining industry, should reduce the impacts of quarries and pits and address the concerns many citizens have about the water resource impacts of aggregate mining.

Acknowledgements

Funding provided by the Minnesota Environment and Natural Resources Trust Fund as recommended by the Legislative Commission on Minnesota Resources. Assistance for the project was provided by the following project partners:

- Aggregate Industries
- Roverud Construction of Spring Grove, Minnesota
- City of Harmony Volunteer Fire Department
- Crane Creek Construction of Owatonna, Minnesota
- Kraemer and Sons of Plain, Wisconsin

- Leitzen Concrete of Rochester, Minnesota
- Minnesota Geological Survey, University of Minnesota
- Milestone Materials Division of Mathy Construction, Onalaska, Wisconsin
- Pederson Brothers Construction of Harmony, Minnesota
- Salem Township, Olmsted County, Minnesota
- University of Minnesota, Geology and Geophysics Department, Hydrogeochemistry Lab

We appreciate the efforts of Tim Schlagenhaft, Jon Ellingson, and DNR Waters' staff in St. Paul who provided peer review of the report, as well as Nick Kroska, who edited the report.

Table of Contents

	Page
Executive Summary	1
I. Research Sections	
1. Scope of the Issue.....	3
2. Study Design.....	9
3. Kraemer Quarry—Prairie du Chien Limestone.....	29
4. Golberg Quarry—Prairie du Chien Limestone.....	35
5. Spinler Quarry—Galena Limestone.....	41
6. Fountain Quarry—Galena Limestone.....	47
7. Harmony Big Spring Quarry—Galena Limestone.....	53
8. Donovan Pit—Alluvial Sand and Gravel.....	57
9. Leitzen-Grabau Pit—Alluvial Sand and Gravel.....	67
10. Felton Pit—Beach Ridge Sand and Gravel.....	69
II. Outcomes Sections	
1. Conclusions.....	81
2. Recommendations to Local Government Units for Quarries and Pits.....	83
III. Appendices	
1. Sampling and Data Collection Methods.....	3
2. Three-Dimensional Characterization of the Spinler Quarry.....	17
3. Glossary.....	33
4. List of References.....	35

Acknowledgements

Funding provided by the Minnesota Environment and Natural Resources Trust Fund as recommended by the Legislative Commission on Minnesota Resources. Assistance for the project was provided by the following project partners:

- Aggregate Industries
- Roverud Construction of Spring Grove, Minnesota
- City of Harmony Volunteer Fire Department
- Crane Creek Construction of Owatonna, Minnesota
- Kraemer and Sons of Plain, Wisconsin
- Leitzen Concrete of Rochester, Minnesota
- Minnesota Geological Survey, University of Minnesota
- Milestone Materials Division of Mathy Construction, Onalaska, Wisconsin
- Pederson Brothers Construction of Harmony, Minnesota
- Salem Township, Olmsted County, Minnesota
- University of Minnesota, Geology and Geophysics Department, Hydrogeochemistry Lab

We appreciate the efforts of Tim Schlagenhaft, Jon Ellingson, and DNR Waters’ staff in St. Paul who provided peer review of the report, as well as Nick Kroska, who edited the report.

List of Tables and Figures

	Page
Executive Summary	
Figure 1. Site map.....	2
Table 1. Summary table of sites and impacts studied.....	3
Figure 2. The impacts on ground-water levels of drawdown at Kraemer Quarry.....	4
Figure 3. Monitoring showed slight turbidity increases after blasting at Fountain.....	5
Figure 4. Temperature monitoring of water at Big Spring Quarry in Harmony.....	6
Figure 5. Donovan pit mining with a hydraulic dredge.....	7
Figure 6. Water level measurements, well nest 1, Donovan Pit.....	7
I. Research Sections	
Figure 1.1. The extent of dewatering.....	3
Figure 1.2. Carbonate rock (limestone and dolostone) areas of Minnesota; quarries are present in the red and yellow areas.....	4
Figure 2.1. Site location map.....	9
Table 2.1. Summary table of sites and impacts studied.....	10
Figure 2.2. Kraemer quarry site photograph.....	12
Figure 2.3. Precipitation data 2001–2005 near Kraemer Quarry.....	13
Figure 2.4. Golberg quarry site photograph.....	14
Figure 2.5. Precipitation data 2001–2005 near Golberg quarry.....	15
Figure 2.6. Spinler quarry site photograph.....	16
Figure 2.7. Precipitation data 2001–2005 near Spinler quarry.....	17
Figure 2.8. Fountain quarry site photograph.....	18
Figure 2.9. Precipitation data 2001–2005 near Fountain quarry.....	19
Figure 2.10. Big Springs quarry site photograph (2003).....	20
Figure 2.11. Big Spring East, the main discharge point in the eastern part of the quarry.....	21
Figure 2.12. Precipitation data 2001–2005 near Big Spring quarry.....	22
Figure 2.13. Donovan pit site photograph.....	23
Figure 2.14. Precipitation data 2001–2005 near Donovan pit.....	24
Figure 2.15. Leitzen-Grabau pit site photograph.....	25
Figure 2.16. Precipitation data 2001–2005 near Leitzen-Grabau pit.....	26
Figure 2.17. Felton pit site photograph.....	27
Figure 3.1. Site by aerial photograph.....	29
Figure 3.2. Seasonal variation of water levels in Kraemer quarry wells.....	30
Figure 3.3. Historic water levels in Kraemer quarry.....	30
Figure 3.4. Water levels at drawdown in Kraemer quarry wells.....	31
Figure 3.5. Comparison of water levels and turbidity in Kraemer quarry wells.....	32
Figure 4.1. Site by aerial photograph.....	35
Figure 4.2. Seasonal variation of water levels in Golberg quarry wells.....	36
Figure 4.3. Impacts of blasting on water levels in Golberg quarry wells.....	37
Figure 4.4. Historic water levels in Golberg Quarry.....	38
Figure 5.1. Site by aerial photograph.....	41
Figure 5.2. Seasonal variation of water levels in Spinler well nest 1.....	42
Figure 5.3. Seasonal variation of water levels in Spinler well nest 2.....	43
Figure 5.4. Seasonal variation of water levels in Spinler well nest 3.....	43
Figure 5.5. Water levels at drawdown in Spinler quarry wells.....	44
Figure 5.6. Water levels in Spinler quarry, 2005.....	45
Figure 5.7. Historic water levels in upper aquifer, Spinler Quarry.....	46

Figure 6.1. Site by aerial photograph.....	47
Figure 6.2. Fountain Big Spring.....	48
Figure 6.3. Fountain Big Spring turbidity after November 4, 2002 blast.....	49
Figure 6.4. Fountain Big Spring turbidity after October 5, 2004 blast.....	50
Figure 6.5. Fountain Big Spring turbidity response to rain.....	51
Figure 7.1. Site by aerial photograph.....	53
Figure 7.2. Springshed dye trace map.....	54
Figure 7.3. Temperature (degrees Celsius) monitoring results.....	55
Figure 8.1. Site by aerial photograph.....	57
Figure 8.2. Floodwaters in the Donovan Pit in 2003.....	58
Figure 8.3. Ground-water levels in the Donovan pit.....	59
Figure 8.4a. Water levels, nest 1.....	60
Figure 8.4b. Water levels, nest 2.....	60
Figure 8.4c. Water levels, nest 3.....	61
Figure 8.4d. Water levels, nest 4.....	61
Figure 8.5. Fluctuations in ground-water temperatures.....	63
Figure 8.6. Trench 1, dye injection point.....	63
Figure 8.7. Trench 1 (left) and trench 2 (right) dye sampling point.....	64
Figure 8.8. Breakthrough curve for the dye trace.....	65
Figure 8.9. Handheld fluorometer.....	66
Figure 9.1. Site by aerial photograph.....	67
Figure 9.2. Depth to water in Leitzen-Grabau wells.....	68
Figure 10.1. Site by aerial photograph.....	69
Figure 10.2. Locations of cross sections in the Felton pit area.....	71
Figure 10.3. Geologic cross section along a trace between the North Fen and the Trust Fund Gravel Pit.....	72
Figure 10.4. Geologic cross section along a trace from the South Fen to the height of the beach ridge south of the Trust Fund Pit.....	73
Figure 10.5. Ground-water flow paths (blue) prior to mining.....	74
Figure 10.6. Ground-water flow paths (blue) during mining.....	75
Figure 10.7. Vertical gradient at North Fen.....	76
Figure 10.8. Vertical gradient at South Fen.....	77

II. Outcomes Sections

III. Appendices

Appendix 1. Sampling and Data Collection Methods

Figure 1. Steel tape.....	3
Figure 2. Electronic water level meter.....	4
Figure 3. Water level measuring at a wellhead.....	5
Figure 4. Climate monitoring equipment.....	6
Figure 5. Introducing dye into the stream of water.....	8
Figure 6. Sampling materials.....	9
Figure 7. Water level and turbidity before and after a blast at Kraemer quarry.....	11
Figure 8. Turbidity readings from a blasting event at Fountain quarry.....	12
Figure 9. Storm induced turbidity response (2004).....	13
Figure 10. Storm induced turbidity response (2003).....	13
Figure 11. Thermochron digital recording thermometer compared with a nickel.....	15

Appendix 2. Three-Dimensional Characterization of the Spinler Quarry

Figure 1.....18
Figure 2.....19
Figure 3.....20
Figure 4a.....21
Figure 4b.....21
Figure 5.....23
Figure 6a.....24
Figure 6b.....24
Figure 7.....25
Figure 8a.....26
Figure 8b.....26
Figure 9.....27
Figure 10a.....28
Figure 10b.....28
Figure 11.....29
Figure 12.....30
Figure 13. (vertical exaggeration 10:1).....31

Hydraulic Impacts of Quarries and Gravel Pits

I. Research Sections

1. Scope of the Issue
2. Study Design
3. Kraemer Quarry—Prairie du Chien Limestone
4. Golberg Quarry—Prairie du Chien Limestone
5. Spinler Quarry—Galena Limestone
6. Fountain Quarry—Galena Limestone
7. Harmony Big Spring Quarry—Galena Limestone
8. Donovan Pit—Alluvial Sand and Gravel
9. Leitzen-Grabau Pit—Alluvial Sand and Gravel
10. Felton Pit—Beach Ridge Sand and Gravel



SECTION 1. SCOPE OF THE ISSUE

Crushed stone and sand and gravel, generally defined as natural aggregate resources, are the building blocks for much of modern society. Rock quarries and gravel pits are common features on Minnesota's landscape. Aggregate mining is an extractive use of resources that may result in the landscape and its hydrology being altered. Operation of quarries and pits has the potential to cause impacts on ground-water and surface-water systems in various ways. This potential causes concerns about mining operations by citizens and state and local officials, as well as mine and pit operators. Quarries and gravel pits often are located in the aquifer itself; thus, water quality impacts can be direct and unmitigated. Ground-water levels surrounding many of these quarries and pits are drawn down to allow dry quarry operations, converting billions of gallons of ground water into surface water annually and reducing ground-water availability for nearby wells, wetlands, springs, streams, and lakes (Figure 1.1).

DNR Waters staff have ongoing involvement in the investigation of the hydrologic impacts of quarries and pits. DNR water resource professionals in all parts of the state are called on to make decisions related to aggregate extraction as part of water appropriation permitting and environmental review and during complaint resolution. The burden on state and local staffs is only exacerbated by the lack of definitive information about the impacts of mining and quarrying. Most information on these topics is anecdotal and little can be found in the literature about the impacts of quarries and pits on water resources.

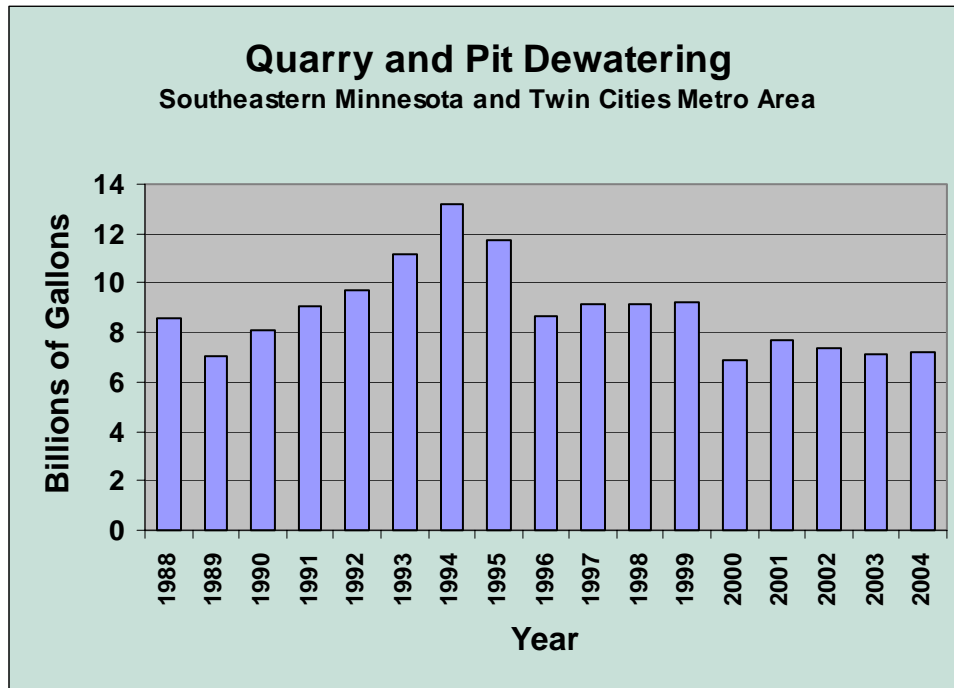

Figure 1.1. The extent of dewatering.

In 1990, the Minerals Division of DNR estimated the number of active and inactive operations at 1500 with the view that this number was likely too low (Dennis Martin, pers. comm.). Quarries for mining limestone, dolomite, sandstone, and hard rock (granite and quartzite) are found in 34 counties. A 1990 Minerals Division inventory found 165 active operations with 88% of those

being limestone quarries (Nelson and others, 1990). That same inventory counted 1,367 inactive operations with 70% of those being limestone quarries.

Aggregate is an important element of our infrastructure; roads, bridges, streets, bricks, concrete, tile, paint, wallboard, roofing products, and glass are some of the commodities requiring aggregate. Concrete pavement and asphalt consist of 90% and 80% aggregate, respectively. Crushed limestone is used for agriculture, medicine, and household products. Nationwide, aggregate mining in 1996 yielded about 3.25 billion tons, approximately two-thirds of nonfuel minerals produced in the United States (USGS Fact Sheet FS 14-97, 1999). Iron ore, dimension stone, and aggregate compose the predominant Minnesota nonfuel mining. Minnesota's nonfuel mineral production ranked fifth in the nation in 2003 (Ewell, 2003) and Minnesota's 2003 production of construction sand and gravel ranked sixth (Bolen, 2004). Minnesota's aggregate industry is a vital component of Minnesota's economy and serves to maintain Minnesota's standard of living. Aggregate demand is expected to continue to expand as Minnesota's economy remains strong and its population grows.

Quarries

Limestone deposits are found in southeastern Minnesota from the Twin Cities south to Iowa and west to Mankato (Figure 1.2). These deposits are fractured; as water moves through the soil it

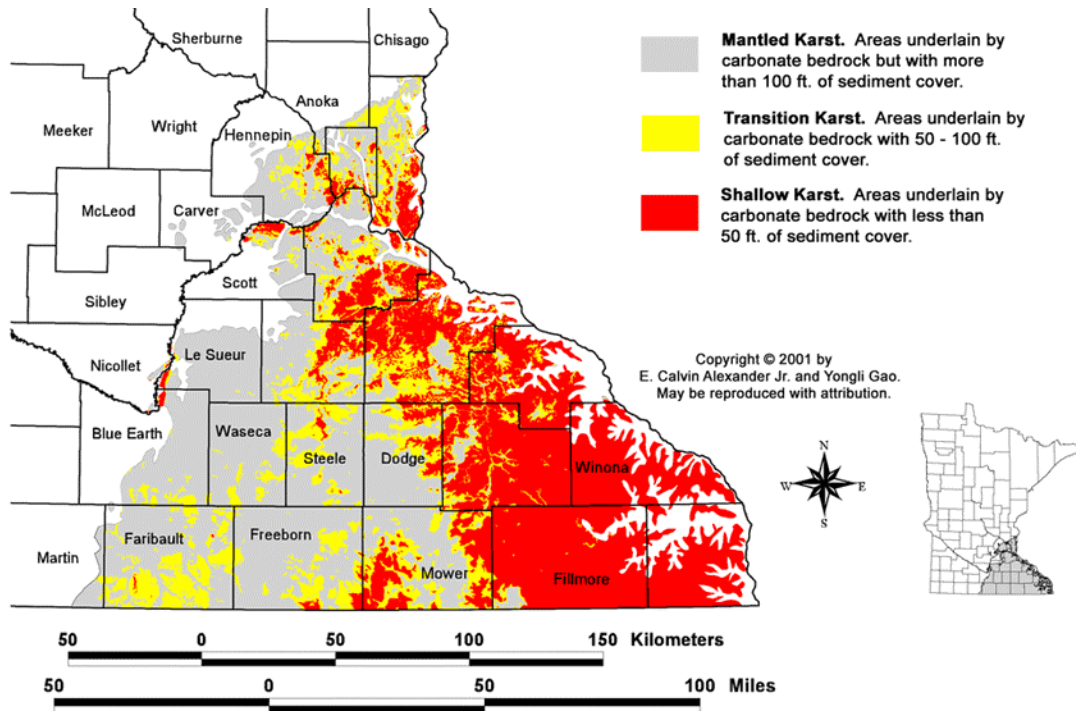

Figure 1.2. Carbonate rock (limestone and dolostone) areas of Minnesota; quarries are present in the red and yellow areas.

mixes with carbon dioxide to form a mildly acidic solution. As this water moves through the fractures, it dissolves the rock, enlarging the fractures and forming a system of conduits to carry ground water. This rock dissolution and conduit creation is the driving process for karst. Drew (1999) described karst, as “an area of limestone or other highly soluble rock, in which the

landforms are of dominantly solutional origin and in which the drainage is underground in solutionally enlarged fissures and conduits.” Whenever limestone is near the surface, it has been exposed to karst processes. Though most of Minnesota does not contain “underground streams”, those portions of the state with karst conditions are the exception. Because ground water in these underground conduits can convey water as rapidly as surface streams, the potential for deterioration of water levels and quality is high. Prediction of flow direction and flow volumes is difficult where there are karst conditions. Ground-water watersheds in karst environments can be and usually are quite different than the land surface watersheds. Water supplies in karst areas are quite vulnerable to unwise land use and the impacts of that use can affect water supplies quite distant from the source.

Limestone quarries are mining in karst aquifers; some of these operations mine below the water table. In order to do this, the quarries must be dewatered. Dewatering can locally depress the water table, altering ground-water flow paths and affecting nearby wells, springs, and surface-water bodies. Interception of a ground-water conduit by a quarry can interfere with ground-water flow paths, pirating the flow and redirecting the discharge to a completely different location (Green and others, 2003).

Two examples of the impacts of limestone quarries that require dewatering can be found in southeastern Minnesota. At Owatonna, Minnesota, the Fretham and Lundin quarries mine below the water table in the Galena limestone and are dewatered for mining. Between 1985 and 1992, DNR Waters staff received several complaints about wells near the quarries going dry or losing pressure. (Pressure loss can be a symptom of a water level that has dropped too close to the level at which the pump is set. Drawdown during active pumping then brings the water level to the pump intake causing the pump to suck in air.) The investigation determined that these wells were also in the Galena limestone and were in fact being impacted by the dewatering. In order to resolve the issue, the quarry operators paid to have the homes connected to the City of Owatonna’s water system. A second example is the Osmundson quarry in the Lithograph City Formation at LeRoy, Minnesota. This below water table quarry requires seasonal dewatering at 250 gallons per minute to 800 gallons per minute. When the quarry is being dewatered, Sweets Spring, approximately 325 yards to the southeast, stops flowing. Dye traces in 1993 and 1994 verified that the quarry pirates the ground-water flow to the spring.

Pits

Generally, sand and gravel operations are found in deposits formed during the advance and retreat of glaciers and in alluvial floodplain deposits formed by streams. Both types of deposits often are critical ground-water aquifers and recharge areas in upland settings; they often are focused discharge zones in stream and river valleys where wetlands and springs depend on continued ground-water flows through the sand and gravel. Because sand and gravel deposits allow comparatively high infiltration rates and relatively rapid rates of water transfer within an aquifer, activities and land uses within and above granular aggregate can have negative effects on ground-water quantity and quality within aquifers. Where decisions are made to leave the sand and gravel deposits in place to provide natural resource values and ground water for human use, the availability of the aggregate resource will be limited. This fact concerns those who plan for the state’s future aggregate production.

One example of the impacts of sand and gravel mining can be found in Clay County where the Buffalo aquifer is the primary potable water supply for the City of Moorhead during drought conditions. Lying within the flat lakebed of Glacial Lake Agassiz (now called the Red River Valley), aquifer recharge rates are very low; replenishment of ground water takes a long time

because the very dense clay sediments that encase the Buffalo aquifer prevent water from reaching the aquifer horizontally. Composed of coarse granular materials, the aquifer is also the closest source of aggregate materials for the Moorhead/Fargo area. Excavation of sand and gravel in this area below depths of about 30 feet actually removes aquifer material from beneath the water table. In the northern one-half of this area, the sands and gravels are protected from direct introduction of fluids and contaminants by a blanket of less permeable silt and clay. The gravel mines create openings (windows) through the overlying silts and clays into the aquifer. Along with direct contamination due to mining operations or neglect after mine closure, the potential of aquifer contamination due to introduction of contaminated floodwaters is significant because the Red River Valley regularly experiences broad overland flooding. Floodwaters incorporate everything from farm chemicals to tanker spills along two major roads (Interstate 94 and U.S. Highway 10). If contaminated floodwaters enter the pit, they can be readily introduced into Moorhead's primary drought period water supply. Along with providing drought supply to Moorhead, the Buffalo aquifer supplies water to surrounding rural farmsteads and several smaller communities in the area.

In recognition of the importance of the aquifer, Moorhead has taken proactive steps to protect their source of water despite the fact that the aquifer is located outside of its jurisdictional boundaries. Acknowledging the low recharge rates into the aquifer due to the protective silts and clays, the city greatly reduced its use of the aquifer, saving it for drought conditions. It has conducted technical studies and developed a wellhead protection plan; it also recognizes that gravel pit windows provide direct conduits for contamination to reach the aquifer and its water supply. Recently, a company opened a new pit above the aquifer to provide fill for Interstate 394 connecting Interstate 94 and U.S. Highway 10 without a permit from Clay County. The city took legal action and worked with the county through their conditional use permit process to substantially reduce the potential of contamination to the aquifer and limit future expansions of the pit.

Study Purpose

The Minnesota Legislature established the Aggregate Resources Task Force in 1998 because of the importance and dwindling supply of aggregate resources. The task force published findings and recommendations "for the management of aggregate resources throughout the state, helping to ensure the continued availability of these resources for future use at reasonable costs while maintaining existing environmental safeguards related to mining" (Southwick and others, 2000). The task force identified that local government units (LGUs) often lack the expertise to assess potential environmental impacts of mining proposals, and rarely do they have budgetary resources to hire consultants of their own to adequately evaluate mining proposals and ensure that environmental safeguards remain in place.

This study and this report are intended to provide the following assistance:

- help local officials, the public, and the mining industry understand the main issues surrounding mine establishment and
- provide suggestions for monitoring and mitigating strategies to prevent significantly harmful impacts on water resources.

The focus of this study was on the following impacts:

- effects on ground-water levels from mining operations and mine dewatering,
- turbidity in wells due to blasting and quarry operations,
- interruption of conduit flow paths by rock removal, and

- temperature change (thermal impacts) in springs and surface-water streams.

This study was proposed for LCMR funding in order to begin systematic evaluation of aggregate mining impacts at test sites in several areas of the state.

SECTION 2. STUDY DESIGN

Project Site Map

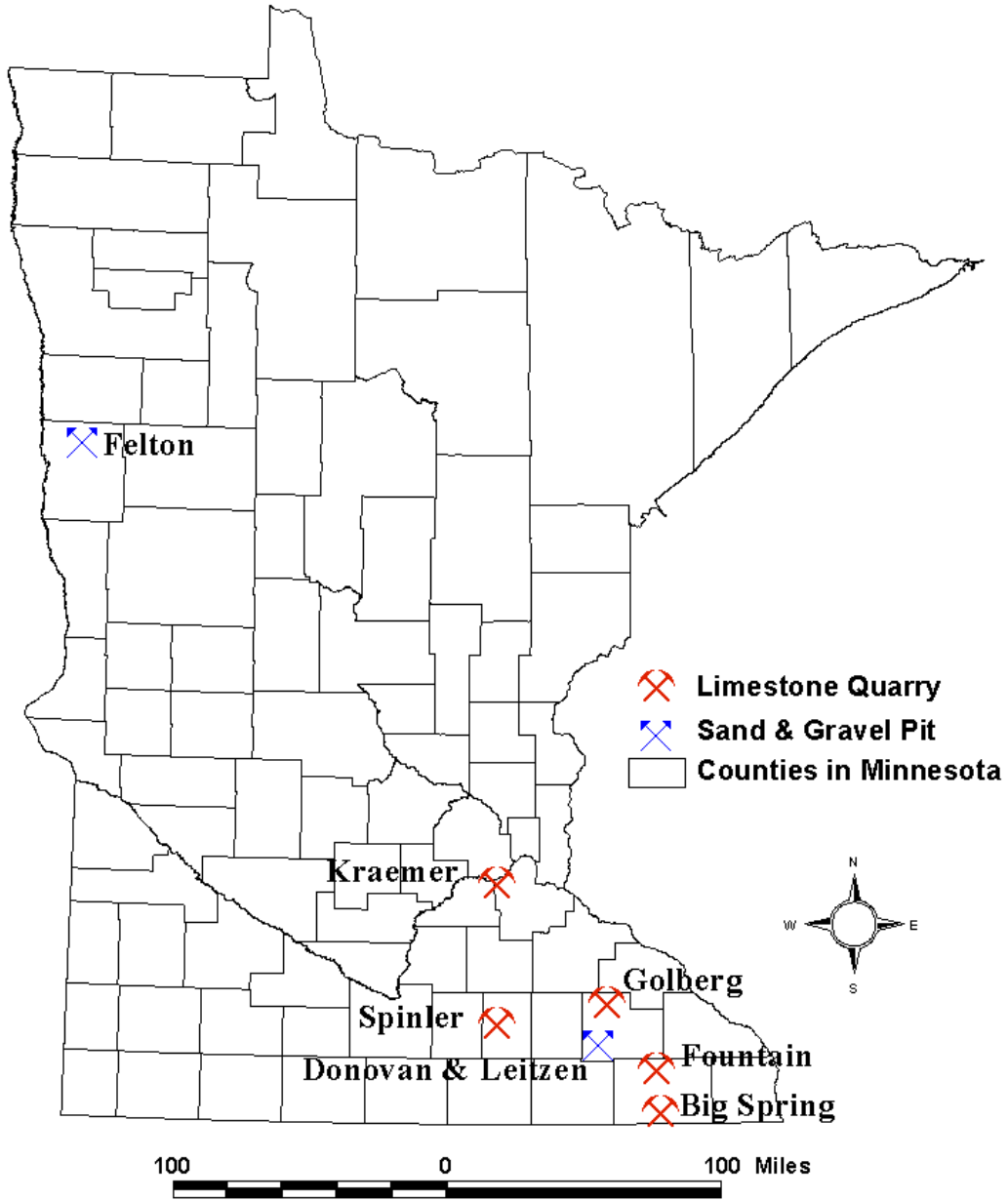

Figure 2.1. Site location map.

Site Selection

Five quarries and three sand and gravel pits were studied (Figure 2.1 above). The limestone quarries are the following:

- Kraemer quarry, Burnsville, Dakota County;
- Golberg quarry, north of Rochester, Olmsted County;
- Spinler quarry, southwest of Owatonna, Steele County;
- Fountain quarry, Fountain, Fillmore County; and
- Big Spring quarry, west of Harmony near the unincorporated village of Big Spring, Fillmore County.

The sand and gravel pits are the following:

- Donovan pit, Salem Township, Olmsted County;
- Leitzen-Grabau pit, Salem Township, Olmsted County; and
- Felton pit, near Felton, Clay County.

Impact Monitoring

Table 2.1 lists the sites and the impacts that were monitored during the project. The text following the table describes the monitoring at the sites.

Site	Mineral resource	Ground-water impacts studied			
		Water level	Turbidity	Temperature change	Spring diversion
Kraemer	Prairie du Chien limestone	X	X		
Golberg	Prairie du Chien limestone	X	X		
Spinler	Galena limestone	X			
Fountain	Galena limestone		X		
Big Spring	Galena limestone			X	X
Donovan	Alluvial sand and gravel	X		X	
Leitzen-Grabau	Alluvial sand and gravel	X			
Felton	Glacial beach ridge sand and gravel	X			

Table 2.1. Summary table of sites and impacts studied.

Water Level

Wells were monitored at three limestone quarries, Kraemer, Golberg, and Spinler, to measure the extent of the impact of dewatering on water levels in the areas around the quarries. All three of these sites are below-water table operations that require dewatering for mining operations to occur. Project funds were used to install wells at all three sites. The Spinler site had additional wells in place that had been installed by the quarry owner as part of its water appropriation permit requirements.

At the Felton, Donovan, and Leitzen-Grabau sand and gravel pits, mining activities occur below the water table. This is “wet mining” involving no dewatering. Monitoring wells had been installed at the Felton mine as part of an ongoing research project to evaluate the mine’s impact on a nearby calcareous seepage fen. At the Leitzen-Grabau and Donovan sites, Salem Township had required the mining companies to install monitoring wells as a stipulation in their conditional use permits. Project funds were used to install a second set of shallow wells at the Donovan pit. The wells at these sites were monitored for mining impacts on ground-water levels. At the Kraemer and Golberg sites, blasting impacts on ground-water levels were also monitored.

Turbidity

At the Kraemer, Golberg, and Fountain sites, blasting impacts on turbidity levels were monitored. The monitoring at Kraemer and Golberg sites was done with turbidity sensors in the monitoring wells. Most limestone and dolostone quarries in Minnesota are dry quarries; the quarrying activities occur above the water table. In these cases, the direct impacts of dewatering on the ground-water system are not manifested. There are, however, issues associated with these dry quarries. Concerns include the impacts these quarries can have on ground-water quality in the area and the particular impacts of mining and blasting on neighboring wells. In order to partially address these issues, we investigated the impacts of the quarry operated by Milestone Materials Division of Mathy Construction near Harmony, Minnesota, on the Fountain Big Spring, which is near the quarry.

Hydraulic Diversion of Spring Flows

The Big Spring quarry is west of Harmony near the unincorporated village of Big Spring. In the early 1960s, the quarry breached conduits carrying ground water to the Big Spring on Camp Creek. Water that formerly discharged directly from the spring now discharges into the quarry. Most of the flow sinks back into a conduit and then discharges from the Big Spring, and the remainder flows overland to Camp Creek. Previous dye tracing work had demonstrated that a significant portion of the springshed (the area contributing flow to a spring) of the Big Spring had been diverted to the quarry. During this project, we were able to use dye tracing to more accurately quantify the extent of this conduit piracy.

Water Temperature

At the Big Spring quarry we began the process of assessing the impact that spring diversions might have on the temperatures of the springs and stream. At the Donovan site, the shallow wells and the pond created by mining were monitored to determine if there were thermal impacts on these systems from mining activities.

Quarry Site Descriptions

Kraemer Quarry



Figure 2.2. Kraemer quarry site photograph.

The Kraemer quarry (Figure 2.2) is located in township 27, range 24W, section 33, a half-mile north of State Highway 13, west of Interstate 35W, and a quarter-mile south of the Minnesota River in Burnsville, Dakota County.

The primary resource being removed from the site by Kraemer and Sons is crushed limestone of various grades. In a cooperative effort between Kraemer and Sons and DNR Waters, three wells were drilled on the southwest part of the property to a depth of about 120 feet. The area that is currently excavated is about 235 acres; however, the total disturbed area is closer to 500 acres.

The precipitation normal for the site is 29.41 inches based on area data from the National Oceanic and Atmospheric Administration (NOAA) from 1971 to 2000. Daily precipitation was collected at station 217538, located 1 mile from the site, by the state climatology program's high-density network. The 2001 through 2005 precipitation is presented in Figure 2.3.

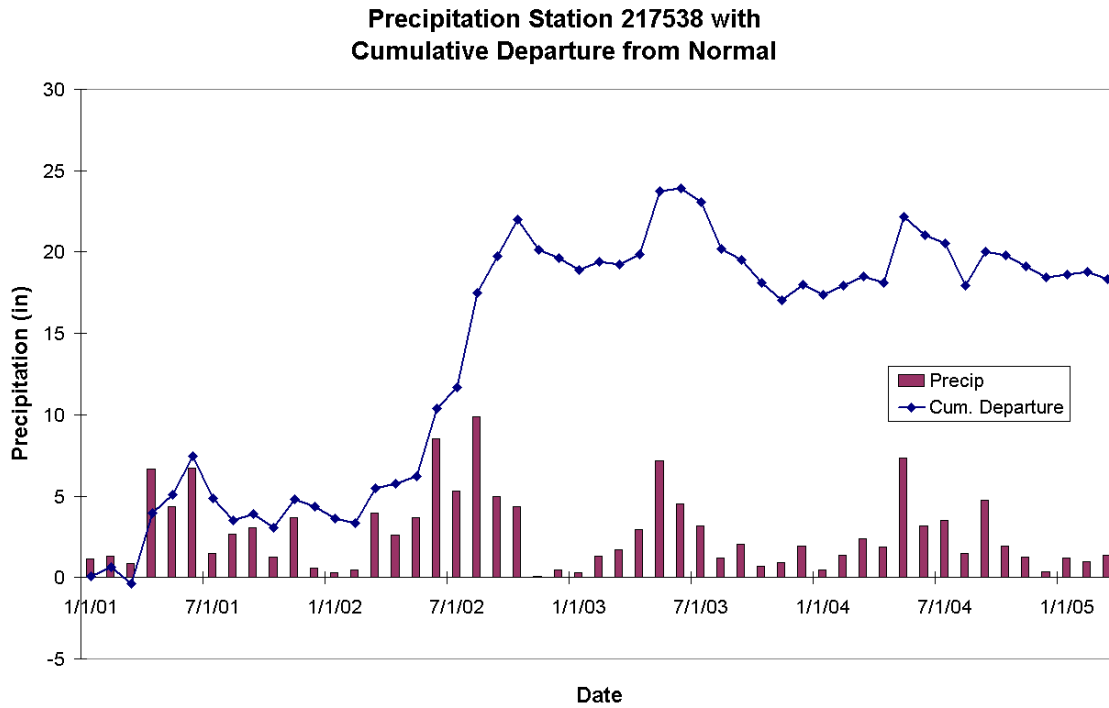

Figure 2.3. Precipitation data 2001–2005 near Kraemer Quarry.

Cumulative departure from normal is a measure of long-term precipitation trends. The departure from normal is calculated by subtracting the 1971–2000 monthly precipitation normals from the monthly precipitation. This is summed over the period of interest providing a measure of precipitation trends. The precipitation in the area has been above normal for the study duration with big increases in precipitation in 2002. The precipitation in 2003 through the first few months of 2005 has been near average.

Golberg Quarry



Figure 2.4. Golberg quarry site photograph.

The Golberg quarry (Figure 2.4) is located in township 108, range 14W, section 36, north of County Road 14 and along the banks of the Zumbro River in Olmsted County. The site is 5 miles northeast of the city of Rochester.

The primary resource being removed from the site by Milestone Materials Division of Mathy Construction is crushed limestone of various grades. In a cooperative effort between Mathy Construction and DNR Waters, two wells were drilled on the north property line to a depth of about 120 feet. The area that is currently being mined is about 51 acres; however, the total disturbed area is closer to 150 acres.

The precipitation normal for the site is 31.40 inches based on area data from NOAA from 1971 to 2000. Daily precipitation was collected at station 217009, located 4 miles from the site, by the state climatology program's high-density network. The 2001 through 2005 precipitation is presented in Figure 2.5.

**Precipitation Station 217009 with
Cumulative Departure from Normal**

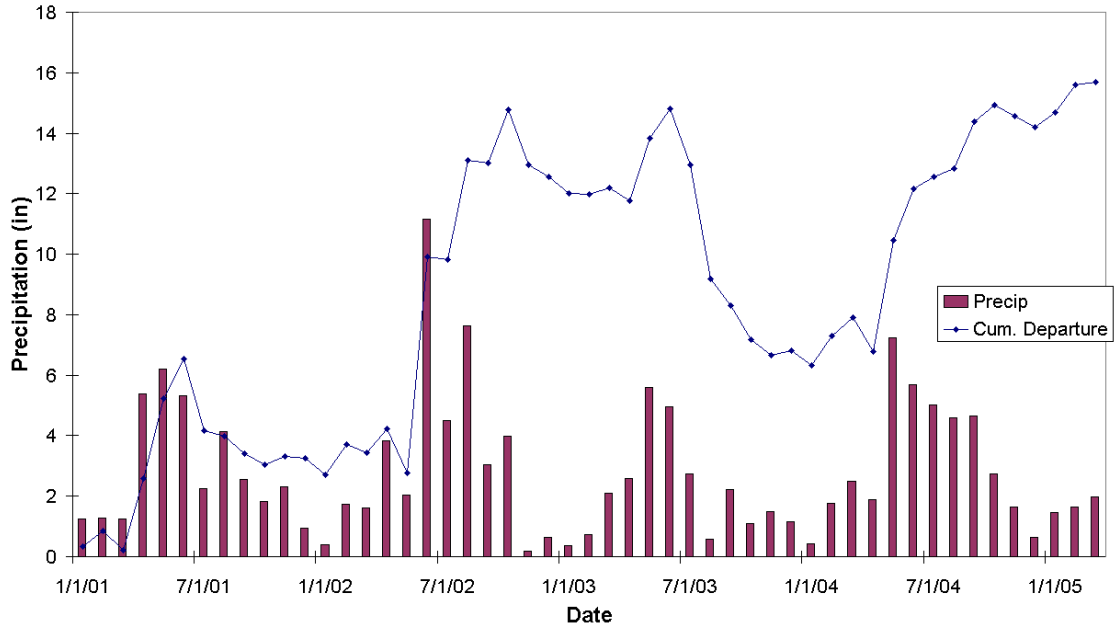

Figure 2.5. Precipitation data 2001–2005 near Golberg quarry.

Cumulative departure from normal is a measure of long-term precipitation trends. The departure from normal is calculated by subtracting the 1971–2000 monthly precipitation normals from the monthly precipitation. This is summed over the period of interest providing a measure of precipitation trends. The precipitation in the area has been above normal for the study duration with big increases in precipitation in the first halves of 2001, 2002, and 2004. It was slightly drier in the second half of 2003, but the overall departure from normal remained positive.

Spinler Quarry



Figure 2.6. Spinler quarry site photograph.

The Spinler quarry (Figure 2.6) is located in township 106, range 21W, section 1, a half-mile west of County Road 30, two miles west of Interstate Hwy 35, south of 51st Road, and a half-mile west of the Straight River in Steele County. The site is 6 miles southwest of the city of Owatonna.

Crushed limestone is the primary resource being removed from the site by Milestone Materials Division of Mathy Construction. The site was initially operated by Crane Creek Construction as a sand and gravel pit but switched to limestone mining when bedrock was reached. In an effort to determine impacts on the local ground water and the Straight River, Crane Creek Construction was required to drill three bedrock wells around the quarry and six shallow sand and gravel wells between the quarry and the river. Two additional shallow wells were drilled by DNR Waters to supplement the information previously gathered. The area that is currently excavated is about 34 acres; however, the total disturbed area is closer to 58 acres.

The precipitation normal for the site is 31.64 inches based on area NOAA data from 1971 to 2000. Daily precipitation was collected at station 216287, located within a mile of the site, by the state climatology program's high-density network. The 2001 through 2005 precipitation is presented in Figure 2.7.

**Precipitation Station 216287 with
Cumulative Departure from Normal**

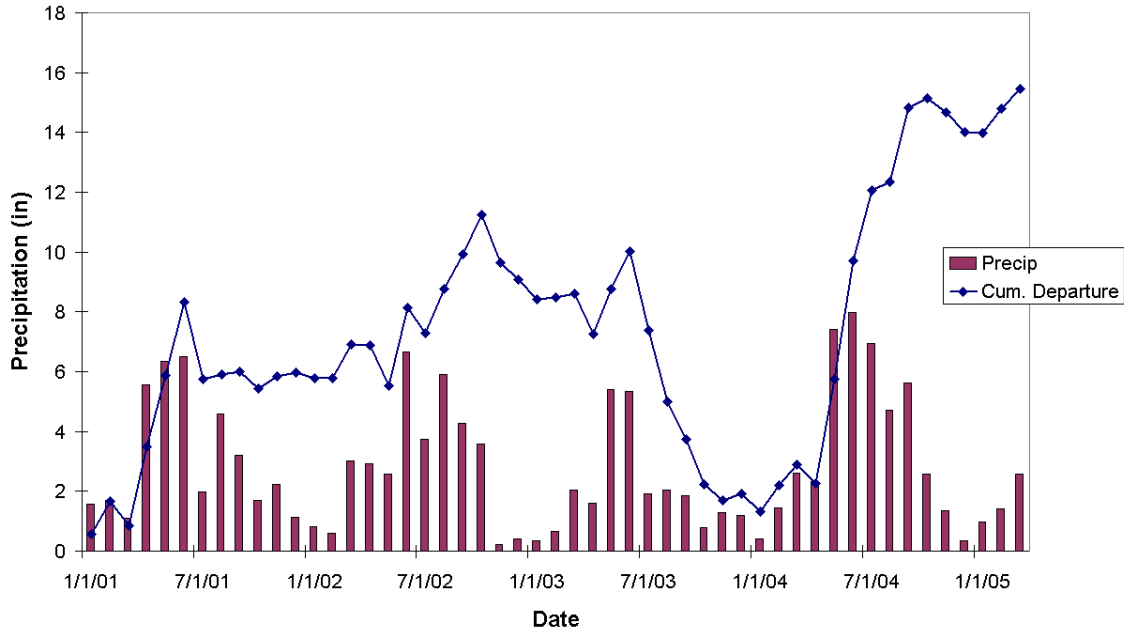

Figure 2.7. Precipitation data 2001–2005 near Spinler quarry.

Cumulative departure from normal is a measure of long-term precipitation trends. The departure from normal is calculated by subtracting the 1971–2000 monthly precipitation normals from the monthly precipitation. This is summed over the period of interest providing a measure of precipitation trends. The precipitation in the area was above normal in the first halves of 2001 and 2004. The precipitation during the remainder of 2001, 2002, and the first half of 2003 was about normal. The end of 2003 was drier than normal.

Fountain Quarry



Figure 2.8. Fountain quarry site photograph.

The Fountain quarry (Figure 2.8) is located in township 103, range 11W, section 3, north of County Road 8, and a half-mile west of U.S. Highway 52 in Fillmore County. The site is 25 miles southeast of the city of Rochester.

The primary resource being removed from the site by Milestone Materials Division of Mathy Construction is crushed limestone of various grades. No wells were installed in the vicinity of the quarry; however, turbidity was being monitored in a spring that was shown to be taking runoff from the quarry floor through a dye trace performed by University of Minnesota Geology Department in cooperation with DNR Waters. The area that is currently being mined is about 24 acres; however, the total disturbed area is closer to 47 acres.

The Fountain quarry is in the flat-lying Stewartville and Prosser Members of the Ordovician Galena Group. The Prosser is fine-grained, thin-bedded limestone with minor shale partings while the Stewartville is fine-grained dolomitic limestone and dolostone (Mossler, 1995). Both of these formations exhibit classic karst features when they are in a shallow setting as they are here. Numerous sinkholes, stream sinks, springs, and caves are found in this area. In the quarry there are four open joints on the floor. These joints generally have water flowing through them except during the driest periods of the year.

The precipitation normal for the site is 34.29 inches based on area NOAA data from 1971 to 2000. Daily precipitation was collected at station 216654, located 10 miles from the site, by the state climatology program's high-density network. The 2001 through 2005 precipitation is presented in Figure 2.9.

**Precipitation Station 216654 with
Cumulative Departure from Normal**

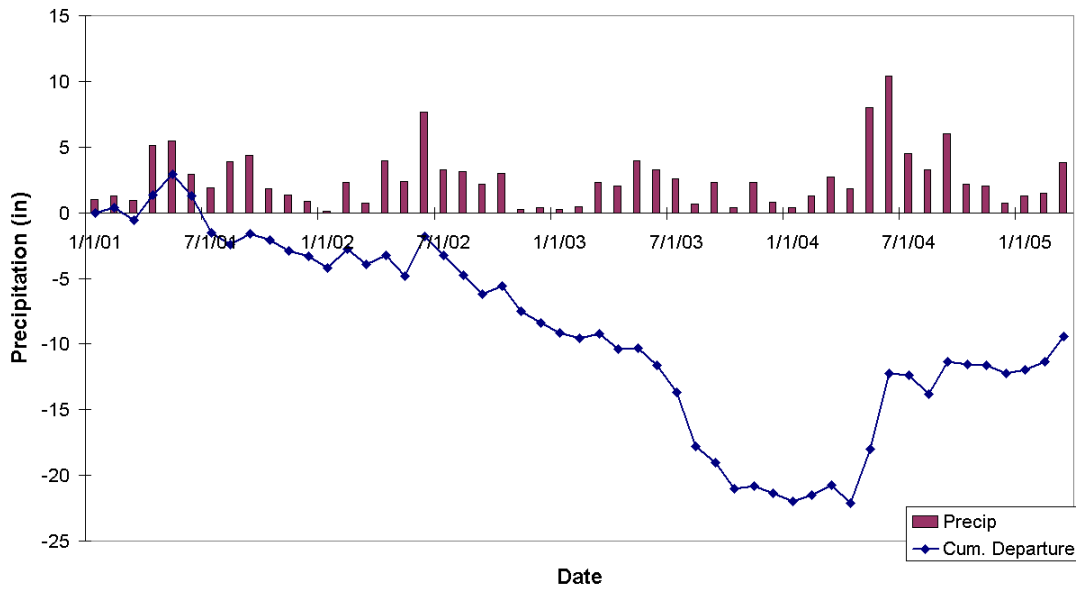

Figure 2.9. Precipitation data 2001–2005 near Fountain quarry.

Cumulative departure from normal is a measure of long-term precipitation trends. The departure from normal is calculated by subtracting the 1971–2000 monthly precipitation normals from the monthly precipitation. This is summed over the period of interest providing a measure of precipitation trends. The precipitation in the area has been significantly below normal through spring 2004. Early summer 2004 was wet and precipitation has been about normal since then; however, a precipitation deficit still exists.

Big Springs Quarry



Figure 2.10. Big Springs quarry site photograph (2003).

The Big Springs quarry (Figure 2.10) is located in township 101, range 10W, section 9, south of County Road 22 and about 2 miles west of U.S. Highway 52 in Fillmore County. The site is near Harmony, Minnesota, 38 miles southeast of the city of Rochester. The primary resource being removed from the site by Pederson Brothers Construction is crushed limestone of various grades.

The Big Spring quarry is in the flat-lying Stewartville and Prosser Members of the Ordovician Galena Group. The Prosser is fine-grained, thin-bedded limestone with minor shale partings while the Stewartville is fine-grained dolomitic limestone and dolostone (Mossler, 1995). Both of these formations exhibit classic karst features when they are in a shallow setting as they are here. In this area they have numerous sinkholes, stream sinks, springs, and caves. In the quarry face, solution conduits up to 3 yards in diameter have been exposed as the quarry has expanded.

The area that is currently being mined is about 35 acres; however, the total disturbed area is closer to 47 acres. In the early 1960s, quarrying operations disrupted the conduits carrying flow to Big Spring (A24), the headwaters of a trout stream, Camp Creek, which lies 550 yards north of the quarry. The owners of the spring have stated that when this disruption occurred, the flow from the spring decreased. At that time, water started rising in the quarry at several different points; some flows overland to Camp Creek while the rest sinks back into the quarry and resurges in Big Spring (A24). This quarry is not actively dewatered. The ratio of overland flow versus resurging flow varies depending on spring stage and runoff events. As the quarry has expanded to the south, the points at which the water discharges in the quarry have migrated south also. Figure 2.11 below is a photograph of Big Spring East, A238, the main point where water discharges in the eastern part of the quarry.



Figure 2.11. Big Spring East, the main discharge point in the eastern part of the quarry.

The precipitation normal for the site is 34.29 inches based on area NOAA data from 1971 to 2000. Daily precipitation was collected at station 213520, located 1 mile from the site, by the state climatology program's high-density network. The 2001 through 2005 precipitation is presented in Figure 2.12.

Cumulative departure from normal is a measure of long-term precipitation trends. The departure from normal is calculated by subtracting the 1971–2000 monthly precipitation normals from the monthly precipitation. This is summed over the period of interest providing a measure of precipitation trends. The precipitation in the area has been about average through summer 2002. In late summer 2002 through the following year, the precipitation was significantly below normal. The end of 2003 was about normal and was followed by a wet spring in 2004. Precipitation has been about normal since then.

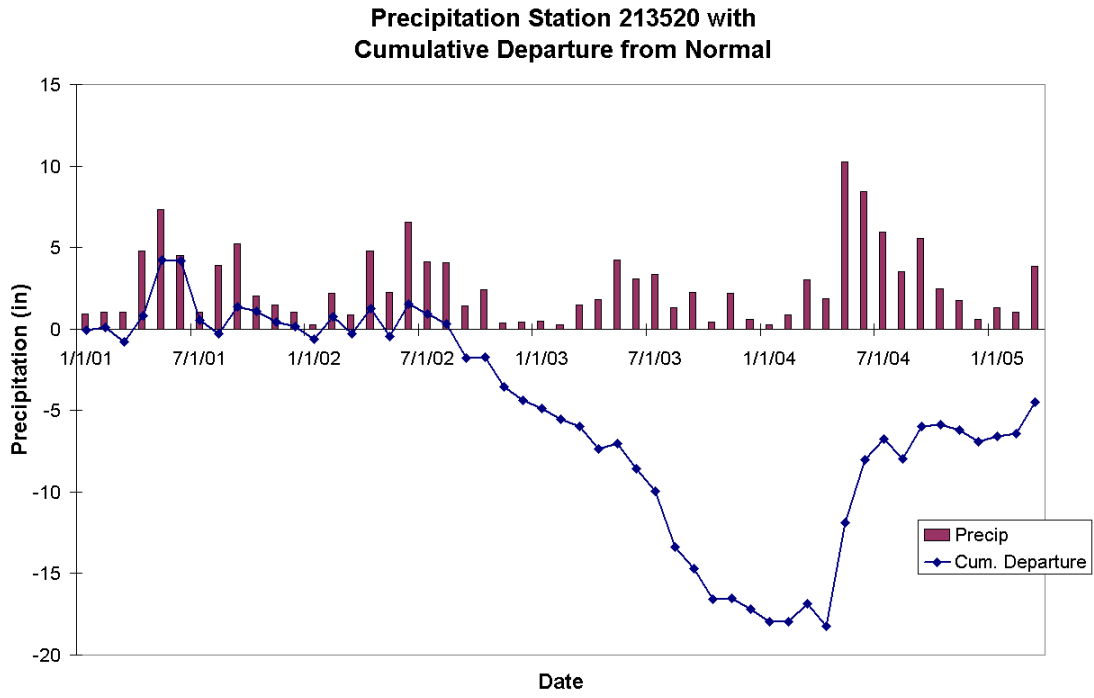

Figure 2.12. Precipitation data 2001–2005 near Big Spring quarry.

Sand and Gravel Pit Site Descriptions

Donovan Pit



Figure 2.13. Donovan pit site photograph.

The Donovan pit (Figure 2.13) is located in township 106, range 15W, section 24, just west of County Road 104 and 250 feet south of the Zumbro River in Olmsted County. The site is in Salem Township, 5 miles southwest of the city of Rochester.

Milestone Materials Division of Mathy Construction is removing sand and gravel from the pit for use in the reconstruction of U.S. Highway 52 through Rochester. As required by the conditional use permit through the township, Milestone Materials Division of Mathy Construction installed three wells to monitor ground-water levels around the pit. One of the company's wells was located upgradient of the pit and two were located downgradient; all were drilled to about 50 feet. Four additional shallow wells (15 to 20 feet deep) were drilled by DNR Waters with project funds to supplement the information provided by the company wells.

The area that is to be mined is about 33 acres; however, the total disturbed area currently is 15 acres. The most recent past use of the site was as an agricultural field on a soybean and corn rotation. The site is located almost entirely within the Zumbro River floodplain and is subject to inundation when the river floods.

The precipitation normal for the site is 31.4 inches based on area NOAA data from 1971 to 2000. Daily precipitation was collected at station 217422, located 4 miles from the site, by the state climatology program's high-density network. The 2001 through 2005 precipitation is presented in Figure 2.14.

**Precipitation Station 217422 with
Cumulative Departure from Normal**

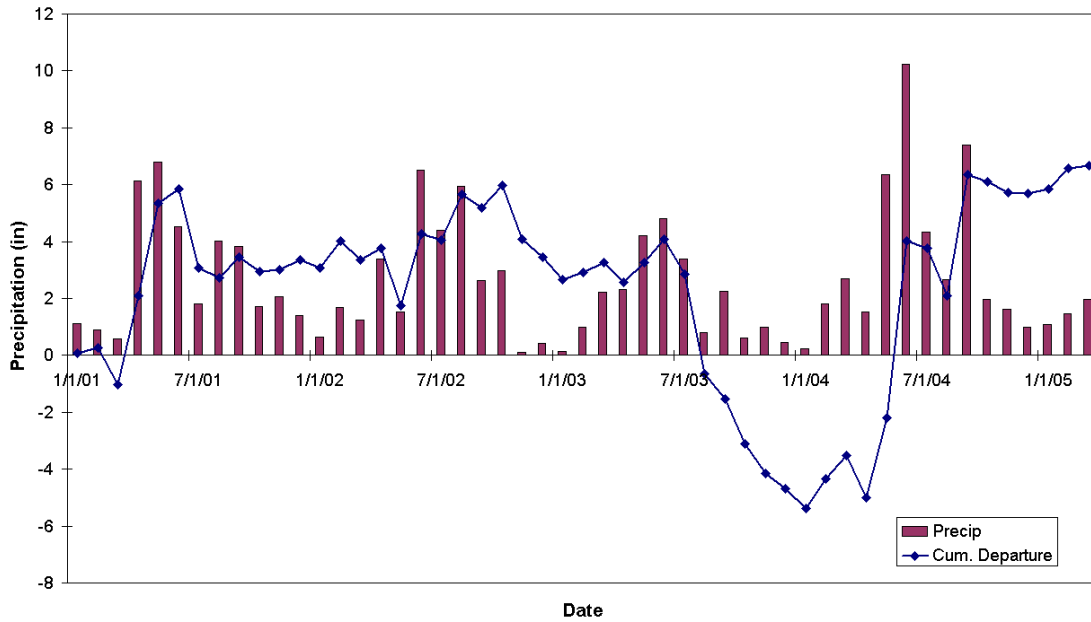

Figure 2.14. Precipitation data 2001–2005 near Donovan pit.

Cumulative departure from normal is a measure of long-term precipitation trends. The departure from normal is calculated by subtracting the 1971–2000 monthly precipitation normals from the monthly precipitation. This is summed over the period of interest providing a measure of precipitation trends. The first half of 2001 was wetter than normal and the second half of 2001 through the first half of 2003 was about normal. The second half of 2003 was drier than normal; however, it recovered in the first part of 2004 and has been about normal through the first couple months of 2005.

Leitzen-Grabau Pit



Figure 2.15. Leitzen-Grabau pit site photograph.

The Leitzen-Grabau pit (Figure 2.15) is located in township 106, range 15W, section 25, just west of 60th Ave SW and south of County Road 117 along the Zumbro River in Olmsted County. The site is in Salem Township, 5.5 miles southwest of the city of Rochester.

The Leitzen-Grabau pit is in an alluvial sand and gravel deposit in the floodplain of the South Fork Zumbro River. Pebbles and cobbles of banded iron ore, granite, and other rocks from northern Minnesota are clear evidence that at least some of the material was transported to the area by glaciers. Since this area was not covered by ice during the last glacial advance, these materials likely date back to an earlier glacial advance. The materials were reworked by the Zumbro River and deposited in the alluvial plain.

The primary resource being removed from the site by Leitzen Concrete is sand and gravel being used in the reconstruction of U.S. Highway 52 through Rochester. As a condition of its conditional use permit through the township, Leitzen Concrete was required to install three wells to monitor ground-water levels around the pit. One well was located upgradient of the pit and two were located downgradient.

The area that is to be mined is about 32 acres; however, the total disturbed area currently is 19 acres. The most recent past use of the site was as an agricultural field on a soybean and corn rotation.

The precipitation normal for the site is 31.4 inches based on area NOAA data from 1971 to 2000. Daily precipitation was collected at station 217422, located 5 miles from the site, by the state climatology program's high-density network. The 2001 through 2005 precipitation is presented in Figure 2.16.

**Precipitation Station 217422 with
Cumulative Departure from Normal**

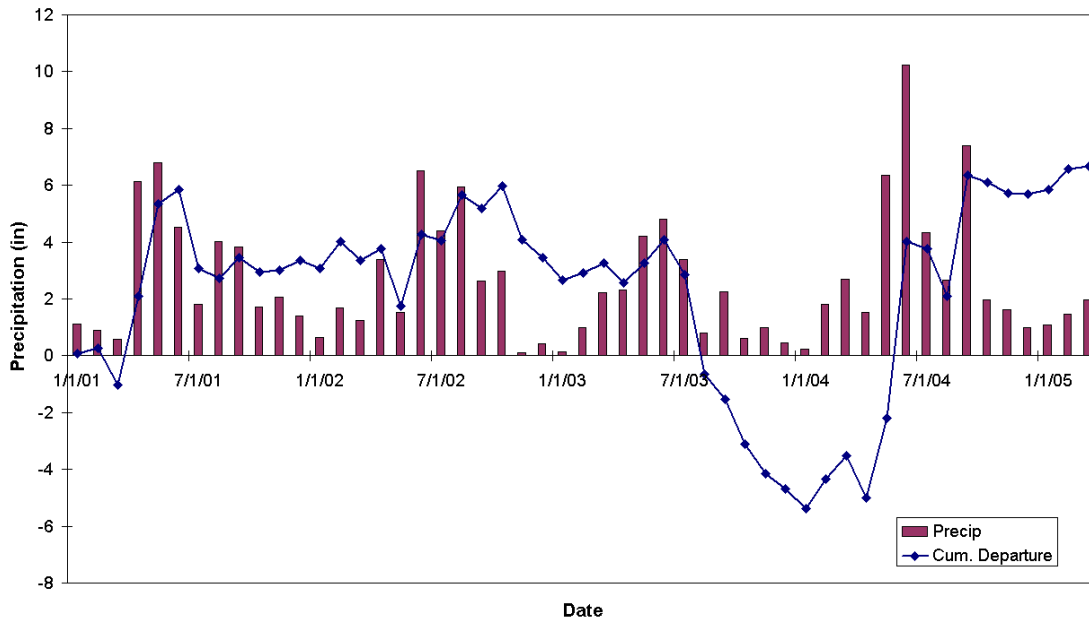

Figure 2.16. Precipitation data 2001–2005 near Leitzen-Grabau pit.

Cumulative departure from normal is a measure of long-term precipitation trends. The departure from normal is calculated by subtracting the 1971–2000 monthly precipitation normals from the monthly precipitation. This is summed over the period of interest providing a measure of precipitation trends. The first half of 2001 was wetter than normal and the second half of 2001 through the first half of 2003 was about normal. The second half of 2003 was drier than normal; however, it recovered in the first part of 2004 and has been about normal through the first couple months of 2005.

Felton Pit



Figure 2.17. Felton pit site photograph.

The Felton study area has several active gravel pits, the largest of which are the Trust Fund Pit and the Clay County Pit. The first is a large open-water gravel pit (Figure 2.17), which is managed by the DNR Division of Forestry for the School Trust Fund. This pit is located in township 142N, range 45W, SW1/4 NW 1/4 section 32. Construction-grade gravel has been removed from the deposit on the Trust Fund parcel since 1959. The lease is currently held by Aggregate Industries. Mined to approximately the ground-water table, the Clay County Pit is situated in township 142N, range 45W, S1/2 section 6. Substantial gravel resources have been identified below the water table in and surrounding the pit.

Both pits are at the western edge of the top of the Lake Agassiz beach ridge. The two calcareous fens, simplistically named North Fen and South Fen, are downslope of and 30 feet lower in elevation than the beach ridge top. The South Fen is located in township 142N, range 46W, SE 1/4 section 36; the North Fen is approximately 1,000 ft northeast of the South Fen in township 142N, range 45W, SW 1/4 NW 1/4 section 31. Contrasting with the relatively flat North Fen (elevation 967), the South Fen slopes approximately 18 feet from its eastern, upgradient edge (elevation 980) to its western edge (elevation 962).

Ground-water gradients were monitored at four well nest locations: at each of the fens and upgradient of each of the fens between the gravel pits and the fens. Water levels were monitored in other single-well installations surrounding both the Trust Fund Pit and the County Pit. Water level monitoring provided the framework for a conceptual model used to assist in assessing the reasons for degradation of the North Fen. A weather station was installed on the southwestern edge of the South Fen, and a staff gage was installed in the open-water pit to record water levels.

The two closest NOAA locations to the study area are Ada (15.5 miles north-northeast) and Halstad (26.7 miles northwest). The precipitation normal for the Ada site is 23.79 inches and for the Halstad site is 19.89 inches based on updated area NOAA data.

SECTION 3. KRAEMER QUARRY—PRAIRIE DU CHIEN LIMESTONE

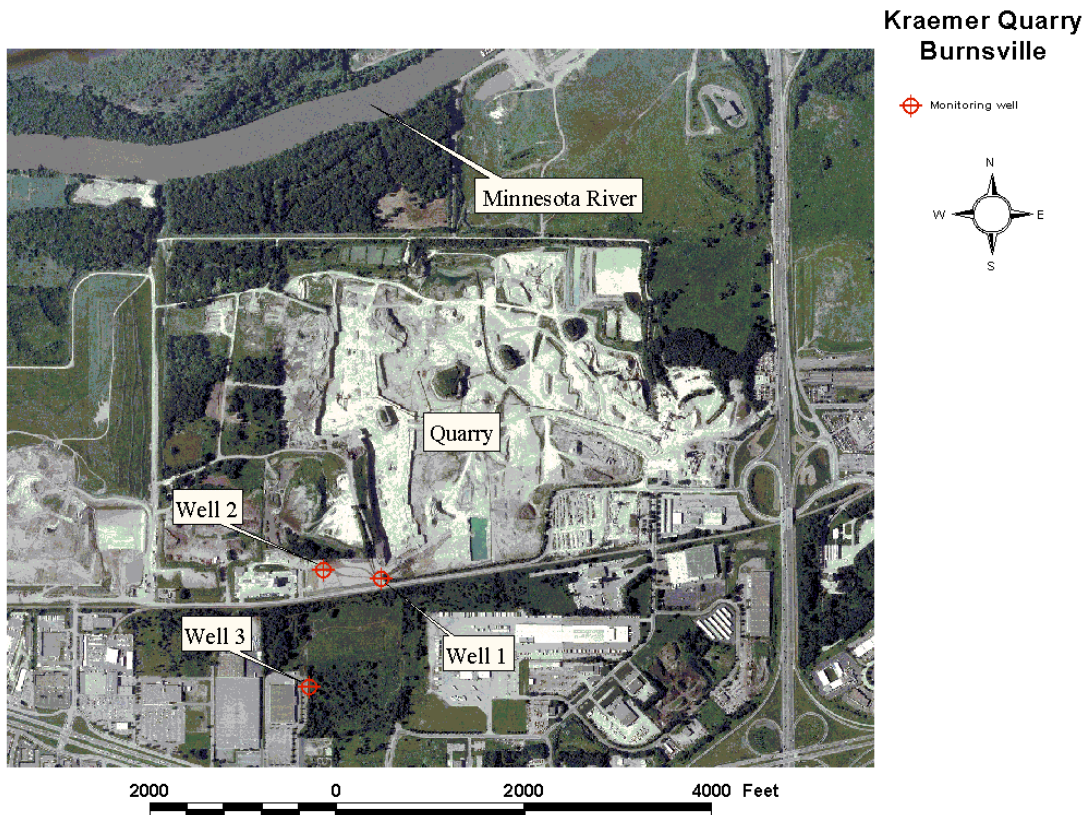

Figure 3.1. Site by aerial photograph.

Impacts on Water Levels

Water level monitoring at the Kraemer quarry was accomplished by measuring water levels in three wells drilled for the project (Figure 3.1). The wells were measured manually several times per month during quarrying activities. Pressure transducers measured water levels at 15-minute intervals. Because the quarry personnel do not turn off the quarry pumps, water levels do not fluctuate very much from year to year. Seasonal variation is usually slight with an increase of less than 3 feet occurring in early summer from snowmelt (Figure 3.2).

A reconstruction of historic water levels (Figure 3.3), using available information from the landscape and all available data, reveals that water levels in the immediate vicinity of the quarry have declined by at least 70 feet since quarrying activities began in 1959 (Figure 3.4). This is largely due to pumping at the quarry, but there are other water users in the area that may also influence the current drawdown. The Kraemer quarry is not the only quarry that has existed in the area, and there may have been depressed water tables due to other quarry operations in the past.

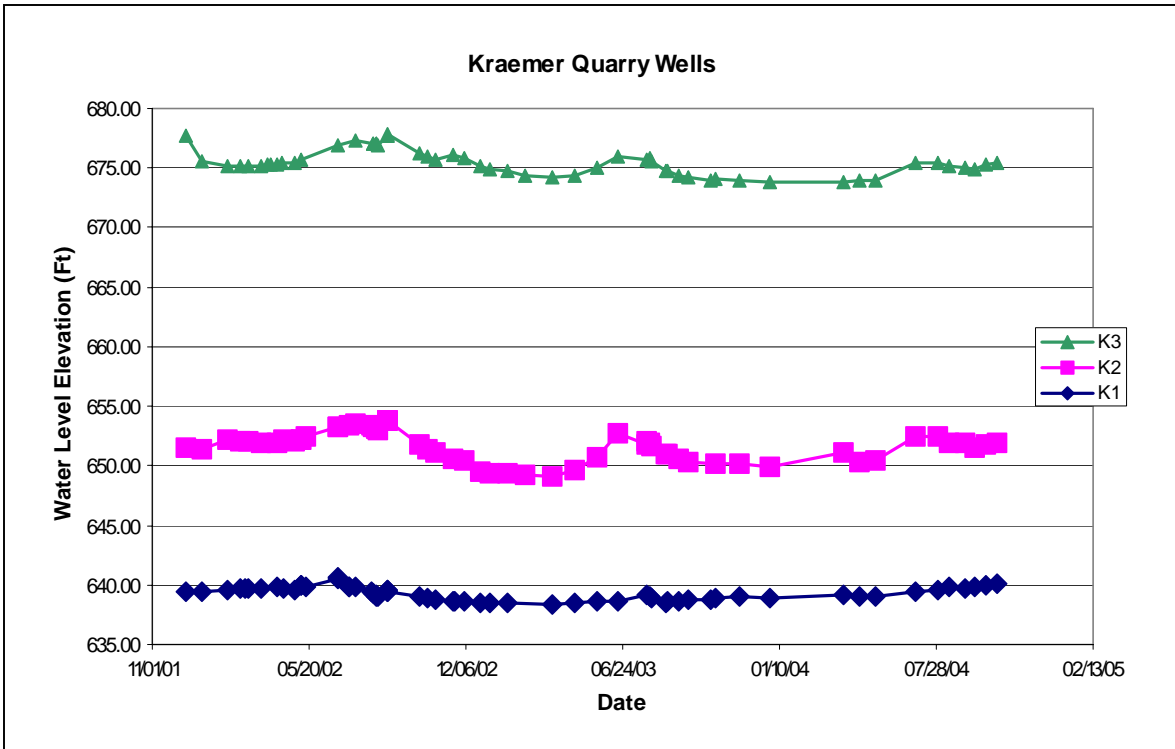

Figure 3.2. Seasonal variation of water levels in Kraemer quarry wells.

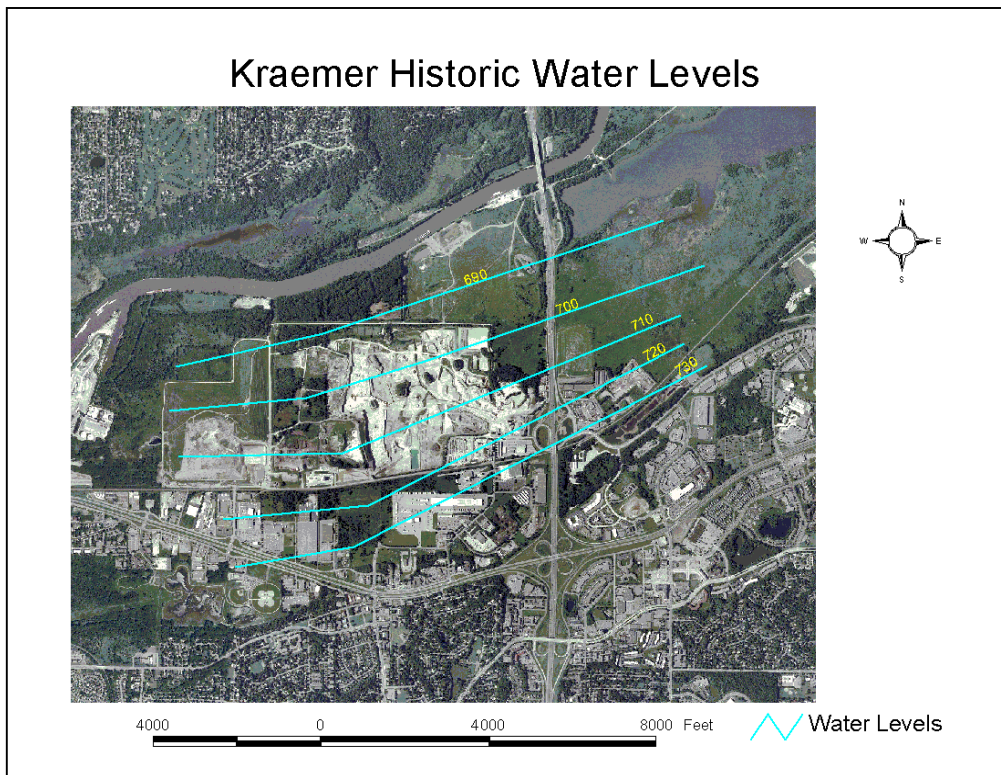

Figure 3.3. Historic water levels in Kraemer quarry.

Kraemer Drawdown 10/12/2004

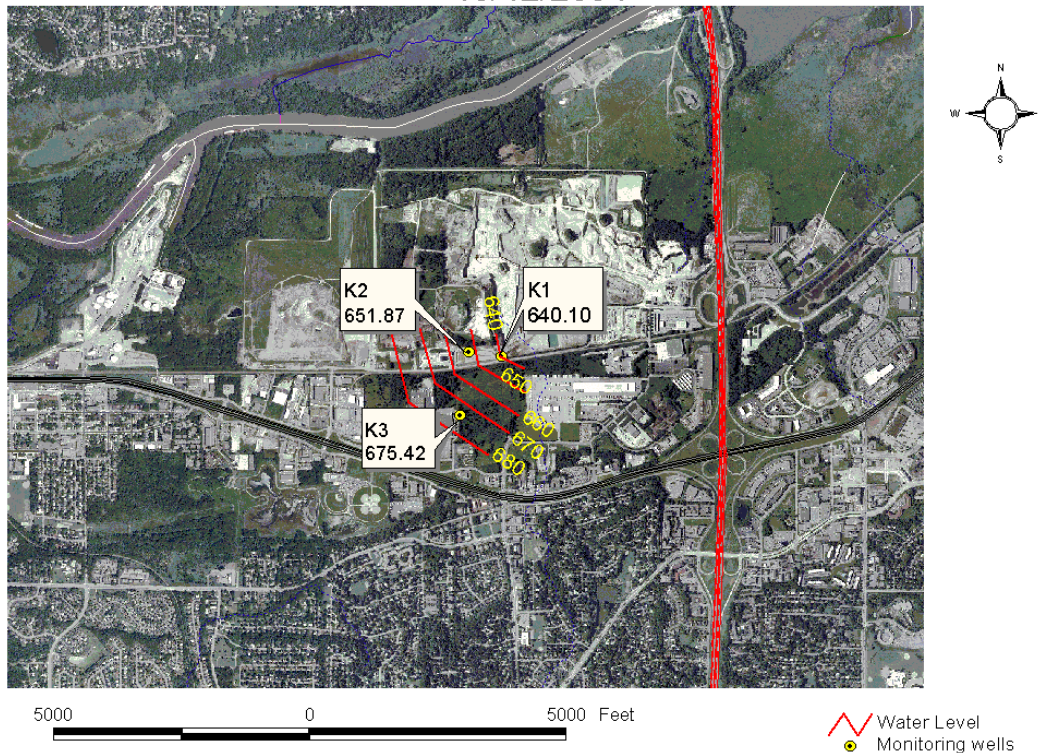

Figure 3.4. Water levels at drawdown in Kraemer quarry wells.

Prior to quarrying and pumping in this area, ground water flowed from the upland toward the Minnesota River, sustaining a series of wetlands parallel to the river along its flowpath. Currently, water flows radially into the quarry from at least the south and west. Flow information is lacking for areas around some of the quarry perimeter; however, given the seepage faces seen around the quarry, it can be assumed that water is flowing into the quarry from all sides. Most emerges from the south and west sides of the pit. Because water levels in the quarry are lower than the water level in the Minnesota River, ground water flows into the quarry from the river on the north side.

Blasting Impacts

Turbidity in the drilled wells was measured with an instrument that can be left in the well to record changes in turbidity. Throughout the monitoring period, no significant changes in turbidity were observed. It is possible that no significant changes occurred because of the lack of variability in pumping and water levels at the site. Monitoring wells such as those at the Kraemer quarry are rarely if ever pumped. The stability of ground-water levels in this quarry and the stability of the pumping level within the quarry is not likely to suddenly dislodge particles that will result in higher turbidity because the water is moving at a relatively stable velocity. Little change in flow likely means little disruption to the matrix.

We were also interested in turbidity changes in response to blasting events. In theory, particles in or near the well could be dislodged by the energy of the blast and cause cloudiness in the water, that is, increased turbidity. Several blasting events were monitored during summer 2002 and 2003 along the southern portion of the west quarry face near the monitoring wells.

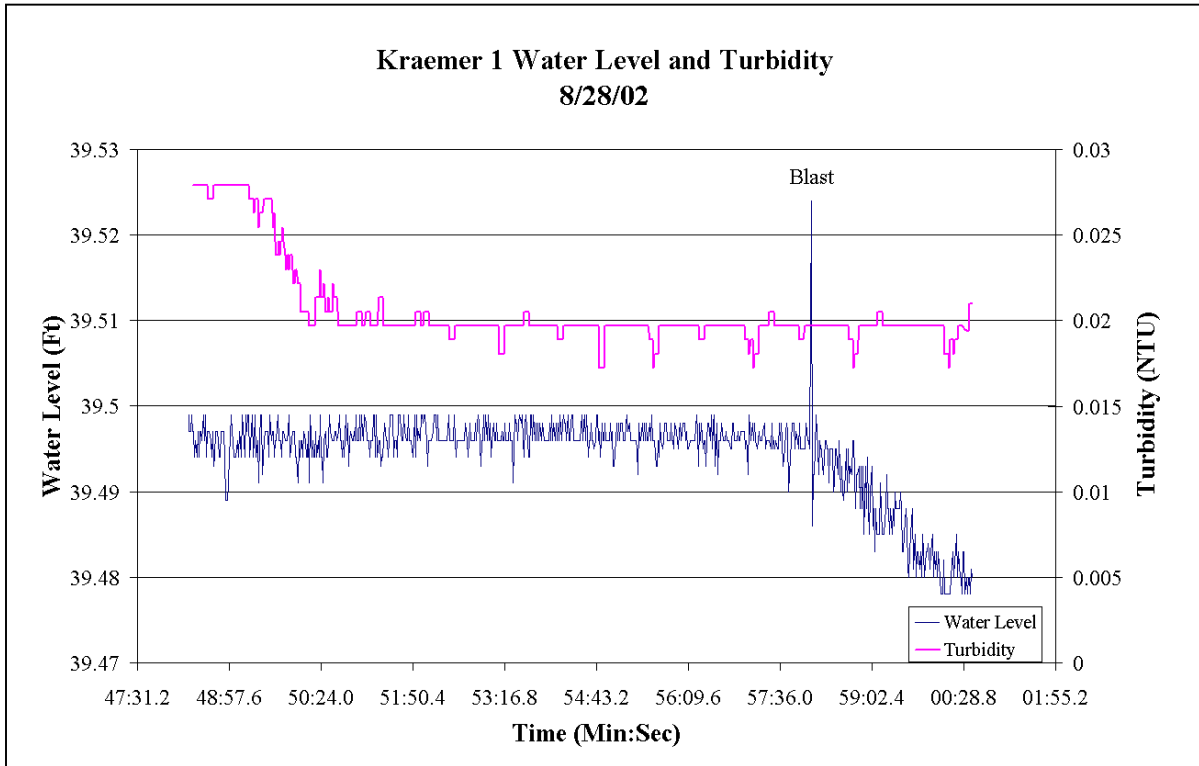

Figure 3.5. Comparison of water levels and turbidity in Kraemer quarry wells.

On August 8, 2002, blasting occurred below the water table. This event is characteristic of most of the data collected during such events. No response is seen in turbidity levels. Because the wells that are monitored in this case are relatively new, there may be little material present to be dislodged.

The blasting results shown in Figure 3.5 reveal a slight change in water level immediately following the blast. A drop in ground-water level is observed that we attribute to the removal of a portion of the rock matrix.

Kraemer Quarry Downhole Camera

Given the inconclusive results of our turbidity monitoring and our determination that the condition of the well may be key to understanding the results, we deployed a downhole camera at Kraemer Quarry on April 7, 2005.

Well 1 is the well closest to the quarry. When it was drilled, the casing terminated below the water table. At the time the well was videologged, the water table was approximately 3 feet below the bottom of the casing. This was a very visible impact of rock removal in the quarry that lowered the water table. The well casing was intact with no apparent damage. One bedrock void

was noted 94 ft below land surface but there was no visible flow. The well had much particulate matter in the form of mats of orange-white material, particles, and areas where the particulate literally formed clouds in the well. The logging terminated at the bottom of the well at 99 ft.

Well 2 is also on the quarry property. The water table was above the casing on this date. The well casing was intact with no apparent damage. Like well 1, this well had much particulate matter in the form of mats of orange-white material, particles, and areas where the particulate literally formed clouds in the well. Bedrock voids were noted at 73.4 ft, 78.7 ft, 81 ft, and 82.4 ft. The void at 73.4 ft was the only one where flow could be observed. As the camera went down the well, particles would slowly settle alongside the camera. At this void, the particles were being pushed into the well by inward flow of ground water. The logging terminated at the bottom of the well.

Well 3 is off-site to the south of the quarry. The water table was above the casing on this date. The well casing was intact with no apparent damage. Like the other two wells, this well had much particulate matter in the form of mats of orange-white material, particles, and areas where the particulate literally formed clouds in the well. Voids were encountered at 63 ft to 65 ft with no visible flow. Below this depth, the water became significantly clearer as the visible amount of particulates dropped by several orders of magnitude. Voids were also encountered at 74.2 ft, 75 ft, 81 ft, and 82.5 ft. The void from 81 ft to 82.5 ft was so large that it encompassed about half of the drill hole. No flow was visible from these voids. At 87 ft, we encountered a larger bedrock ledge at the base of a void. This void appeared to have alluvial gravel material on its floor. This ledge was so large that it would have made camera retrieval problematic if the camera was lowered past it. Therefore, logging was terminated at 87 ft.

Conclusions

Dewatering at this quarry has profoundly affected ground-water levels in the Prairie du Chien aquifer in the area around the quarry. The primary impact of dewatering is the alteration of the water table and resulting draining of adjacent wetlands.

The lack of turbidity change indicates that the turbidity levels were fairly constant and probably more related to the density of bacterial mats floating in the well than anything that happened in the aquifer. Even with frequent blasting, turbidity wasn't observed to be a problem at the site. Quarrying operations had no visible impact on the integrity of the observation well's casing. The casings all appeared to be intact and in good condition. No holes, ruptures, or seam failures were visible.

Based on this work, future monitoring projects should use videologging prior to the start of monitoring. In this case and if monitoring is resumed in these wells, turbidity loggers could in particular be placed at the active conduit in Kraemer well 2 and in the large void zone in Kraemer well 3. This fine-tuning of instrument placement may allow more accurate data to be obtained. These video logs will also serve as a point of reference when DNR Waters staff run the camera down these wells again in 3 to 5 years.

SECTION 4. GOLBERG QUARRY—PRAIRIE DU CHIEN LIMESTONE

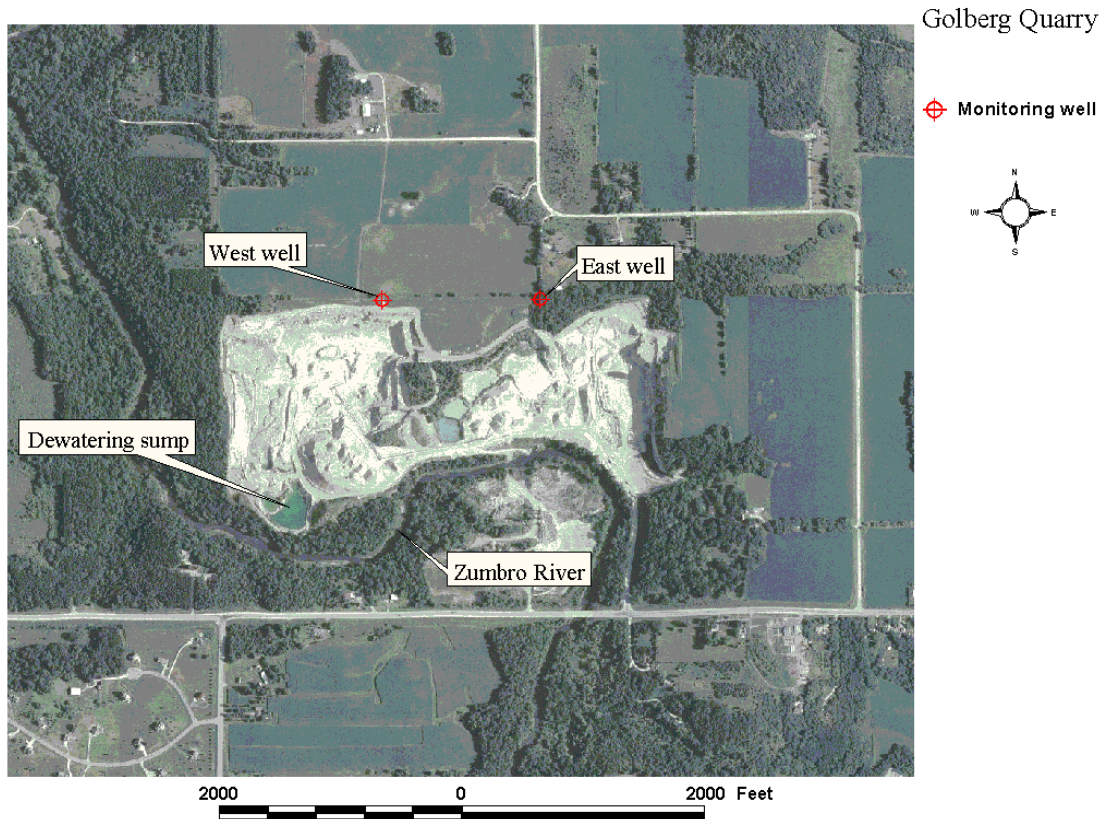

Figure 4.1. Site by aerial photograph.

Impacts on Water Levels

The two drilled wells on the quarry site (Figure 4.1) were measured several times per month during quarrying activities, and pressure transducers measured water levels at 15-minute intervals. The quarry company does not turn off the pumps during winter, and the quarry expansion toward the wells has removed rock, which has caused ground-water levels to decline. Ground-water levels usually rise seasonally during late spring or early summer from snowmelt (Figure 4.2).

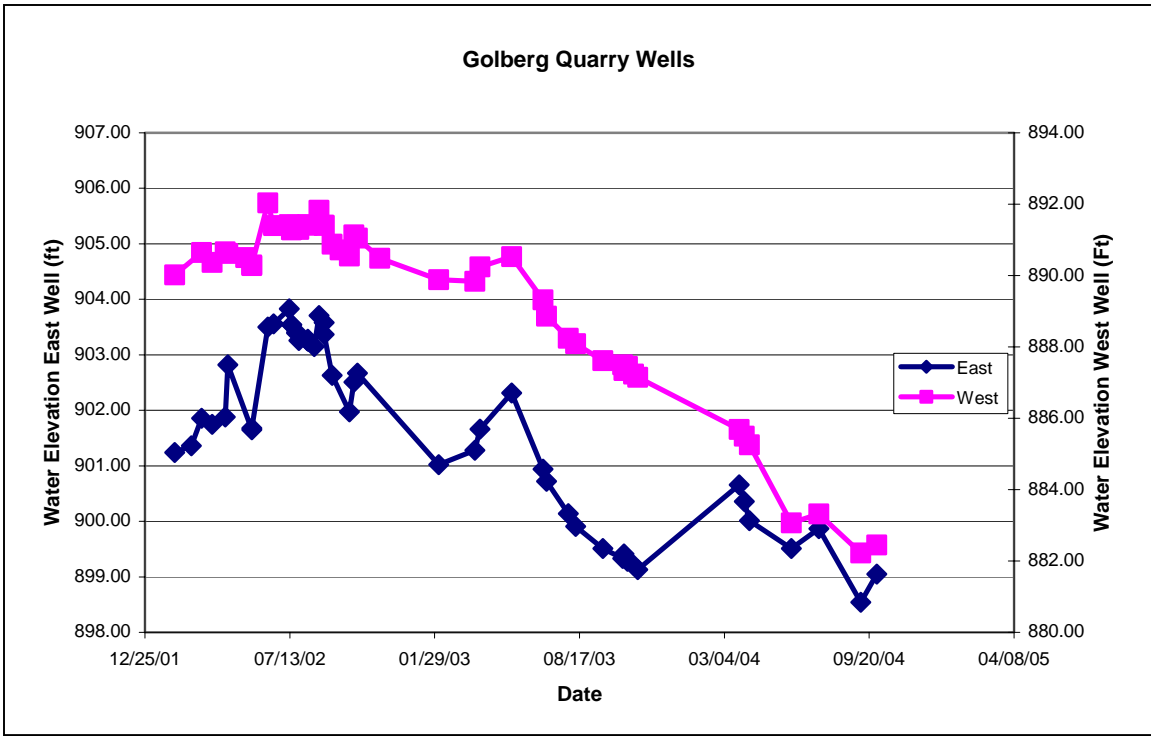

Figure 4.2. Seasonal variation of water levels in Golberg quarry wells.

Blasting Impacts

Blasting events were monitored during 2002 while the pit was expanded north. Similar to results at the Kraemer site, ground-water levels changed immediately following the blast (Figure 4.3). We were also interested in turbidity changes in response to blasting events. In theory, particles in or near the well could be dislodged by the energy of the blast and cause cloudiness in the water, that is, increased turbidity. Several blasting events were monitored during summer 2002 while active blasting occurred along the quarry face near the monitoring wells. There was no effect from blasting on turbidity levels. Because the wells that are monitored in this case are relatively new, there may be little material present to be dislodged.

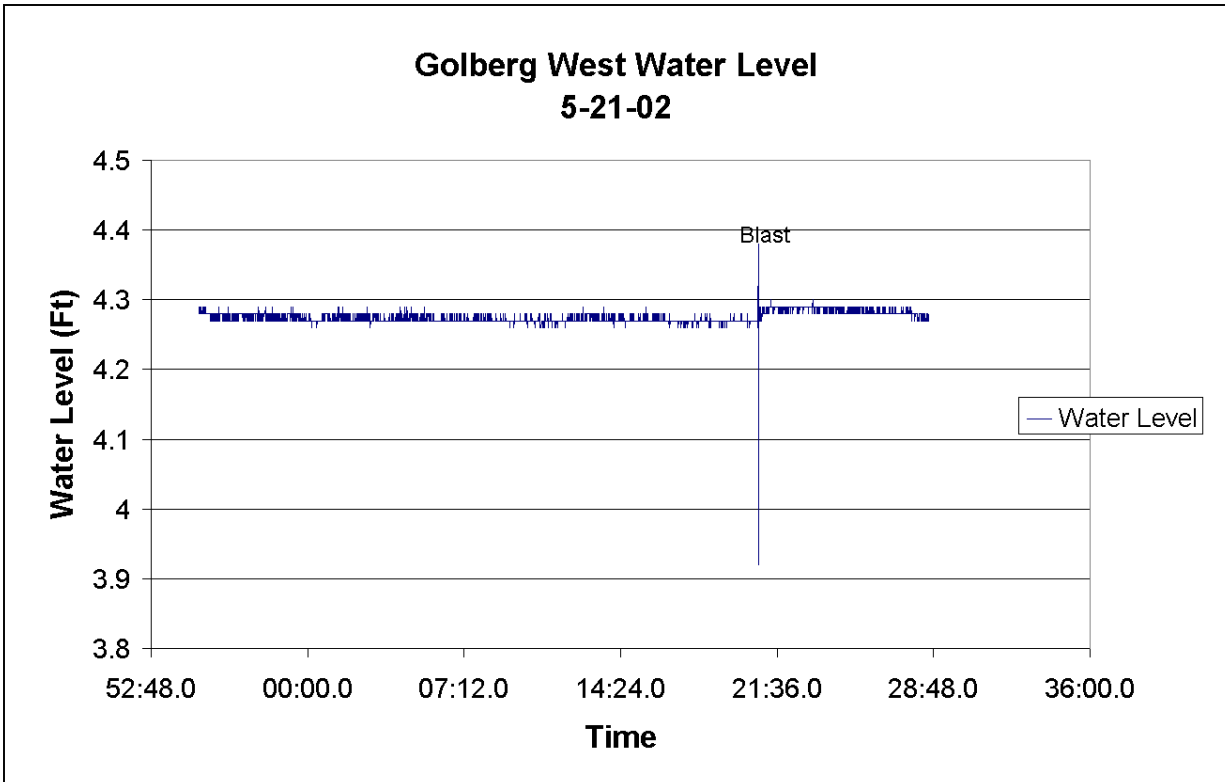

Figure 4.3. Impacts of blasting on water levels in Golberg quarry wells.

Historically, ground water flowed from the northeast to the southwest, toward the Zumbro River. The dewatering and excavation of the quarry has lowered ground-water levels about 40 feet at the north side of the quarry (Figure 4.4). This drawdown is a result of quarry operations since no other large water users are in the immediate area.

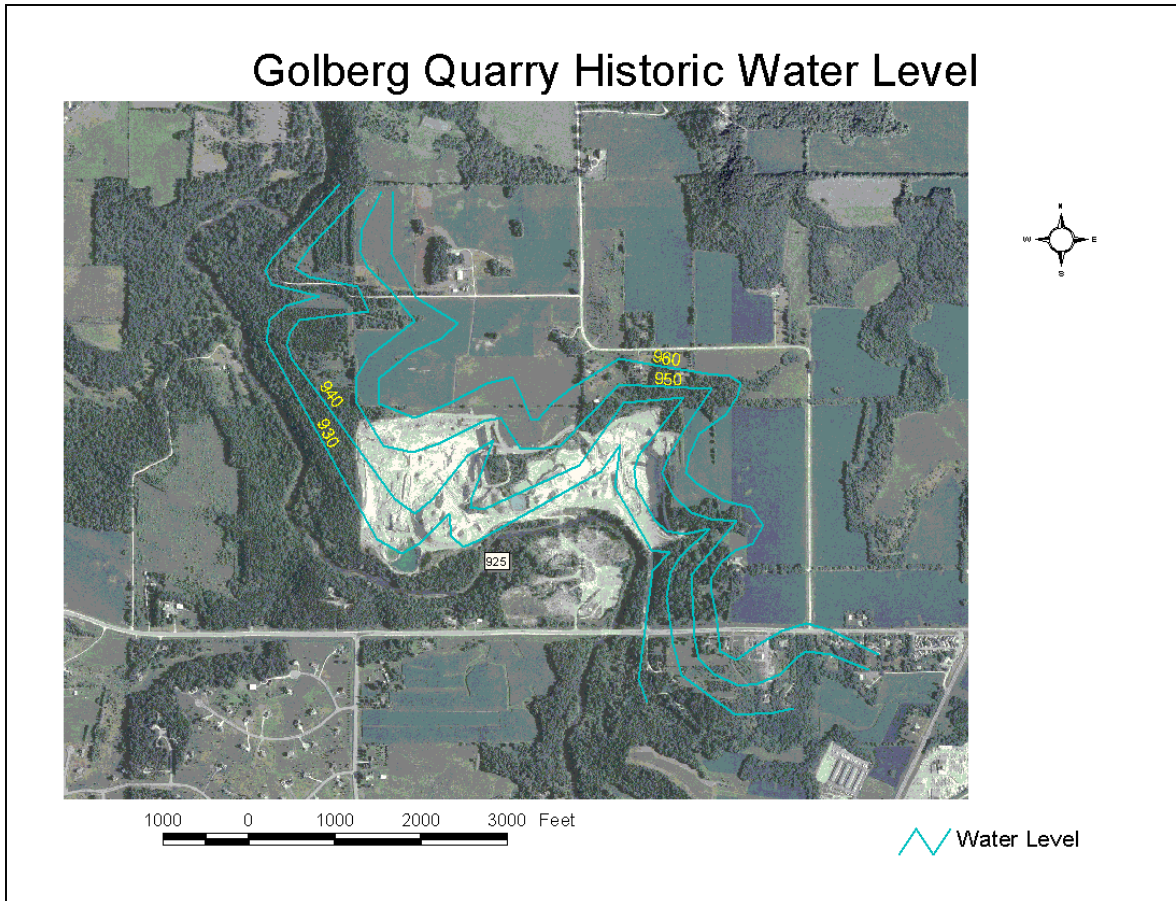

Figure 4.4. Historic water levels in Golberg Quarry.

Golberg Quarry Downhole Camera

Well 1 is on the quarry property on the north side of the mining area. The water table was above the casing on this date. The well casing was intact with no apparent damage. The well had much particulate matter in the form of mats of orange-white material, particles, and areas where the particulate literally formed clouds in the well. Voids were visible at 109 ft, 121 ft, and 129 ft. There was no evidence of flow at any of these points.

Well 2 is on the quarry property on the north side of the mining area to the west of well 1. The water table was above the casing on this date. The well casing was intact with no apparent damage. The well had much particulate matter in the form of mats of orange-white material, particles, and areas where the particulate literally formed clouds in the well. Prominent voids were encountered at 127.5 ft and 151.5 ft; neither point had evidence of flow.

Conclusions

The primary impact of the quarry is a continual decline in water levels in the Prairie du Chien aquifer from historical levels. Additionally, most wells were drilled after state rules were developed to prevent the drilling of wells into the first aquifer in karst terrains. These rules were designed to protect the wells from contamination from surface sources, but they also protect the wells from the quarry dewatering. Quarrying operations had no visible impact on the integrity of the observation well's casings. The casings all appeared to be intact and in good condition. No holes, ruptures, or seam failures were visible. Blasting had no impact on turbidity levels in the monitoring wells onsite.

SECTION 5. SPINLER QUARRY—GALENA LIMESTONE

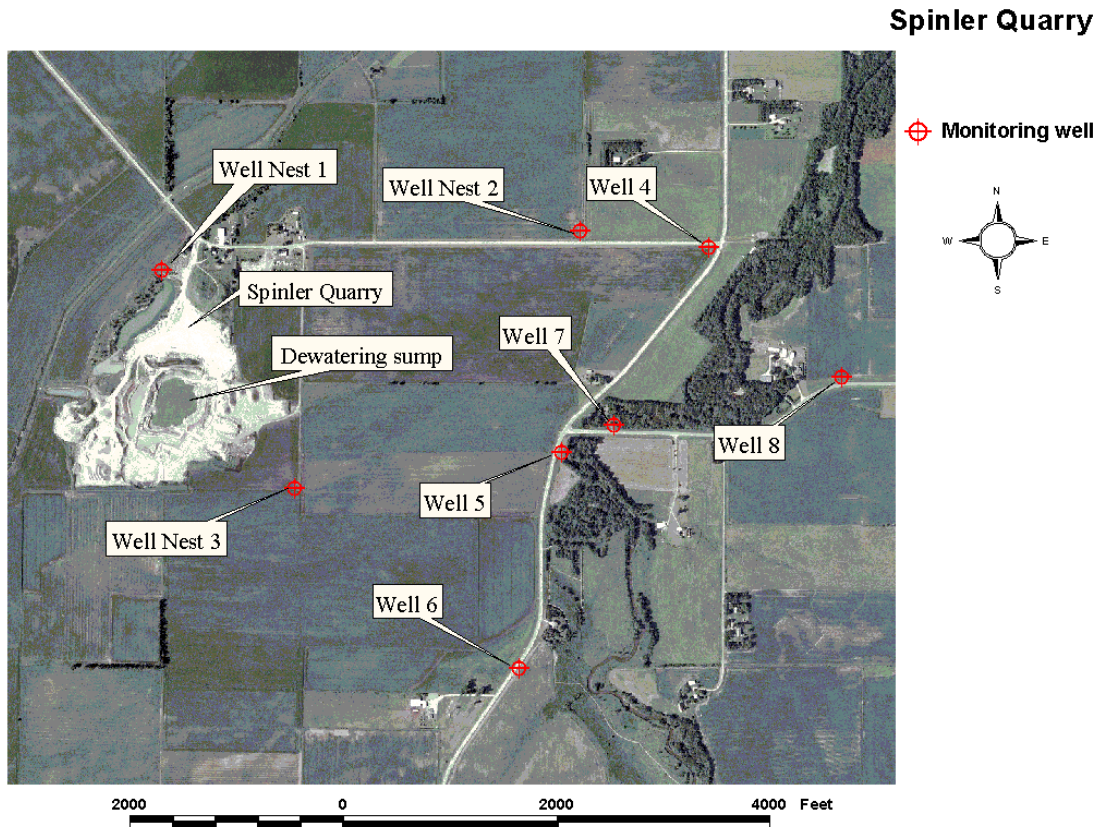

Figure 5.1. Site by aerial photograph.

Impacts on Water Levels

Over the course of the study, the water levels in 11 wells (six wells in three well nests and five other wells) at the site (Figure 5.1) were monitored for changes due to pumping and seasonal variation. Six wells in three well nests around the quarry provide information about vertical directions of ground-water movement (Figures 5.2, 5.3, and 5.4).

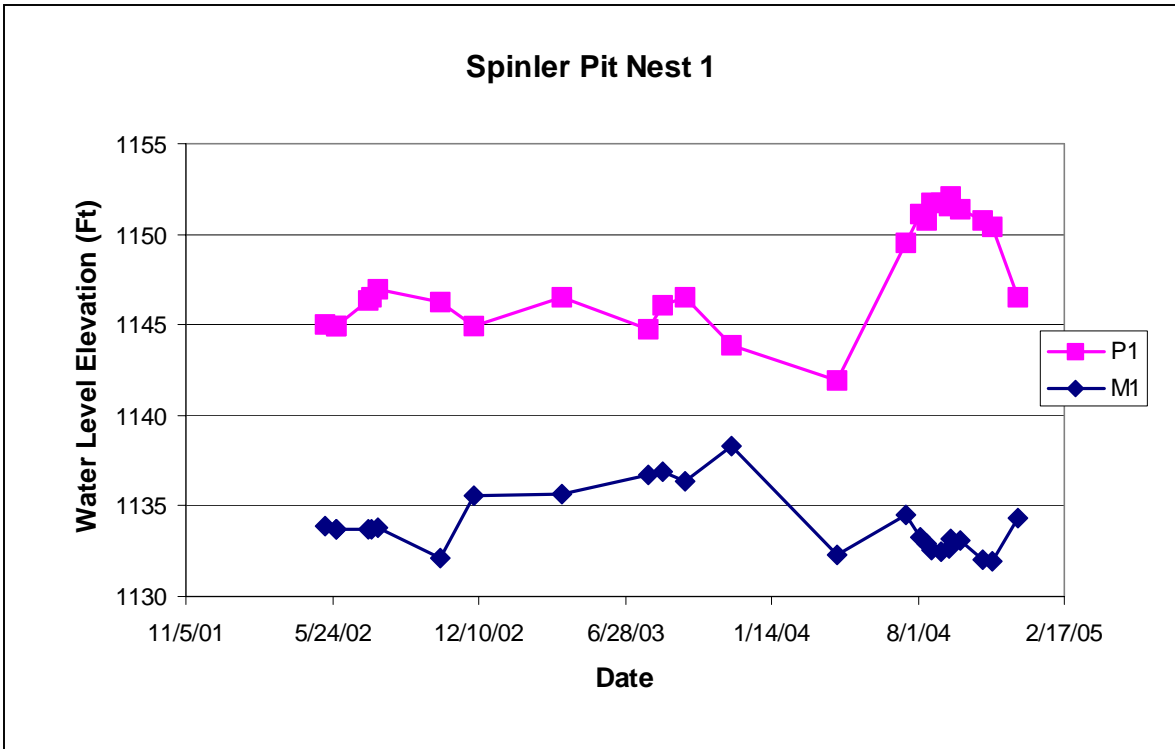

Figure 5.2. Seasonal variation of water levels in Spinler well nest 1.

P1 is a shallow well in the sand and gravel aquifer, and M1 is a deep well in the Galena limestone. They are separated by a thick clay layer, which results in two distinct aquifers. The quarry company is pumping from the lower aquifer, represented by M1, into a series of settling ponds that feed the upper aquifer, represented by P1. Water levels do not fluctuate much from year to year because the company has not been operating any deeper and keeps the pumps running almost constantly. The pumping of water into the higher aquifer also keeps the cone of depression from extending too far west.

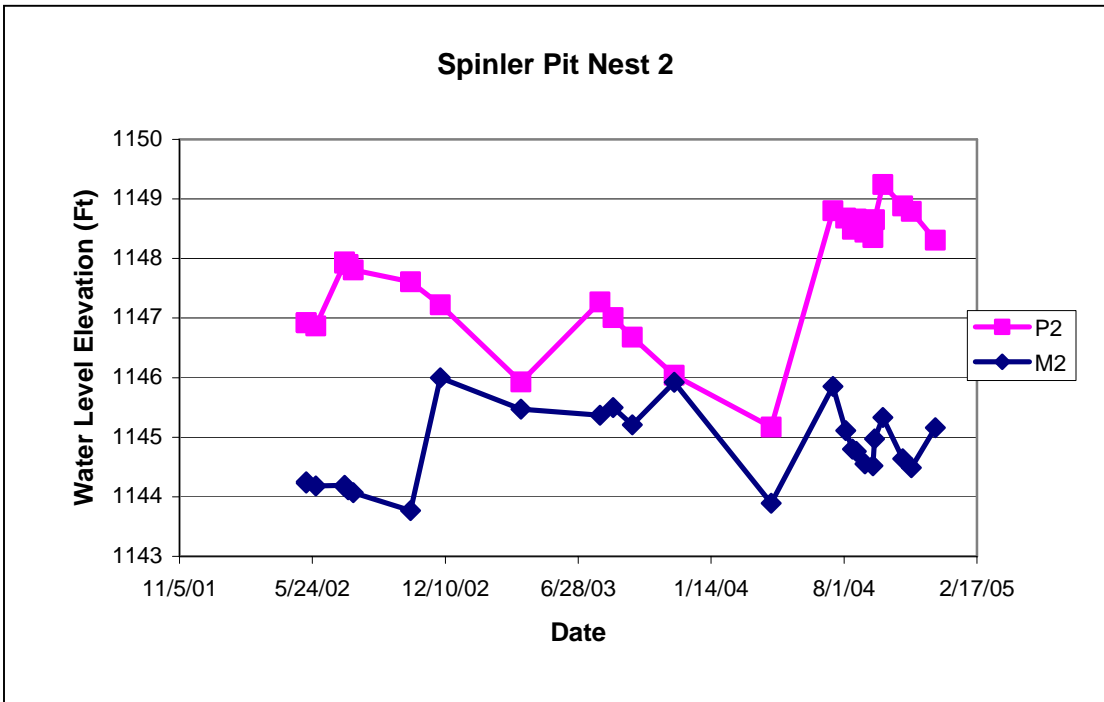

Figure 5.3. Seasonal variation of water levels in Spinler well nest 2.

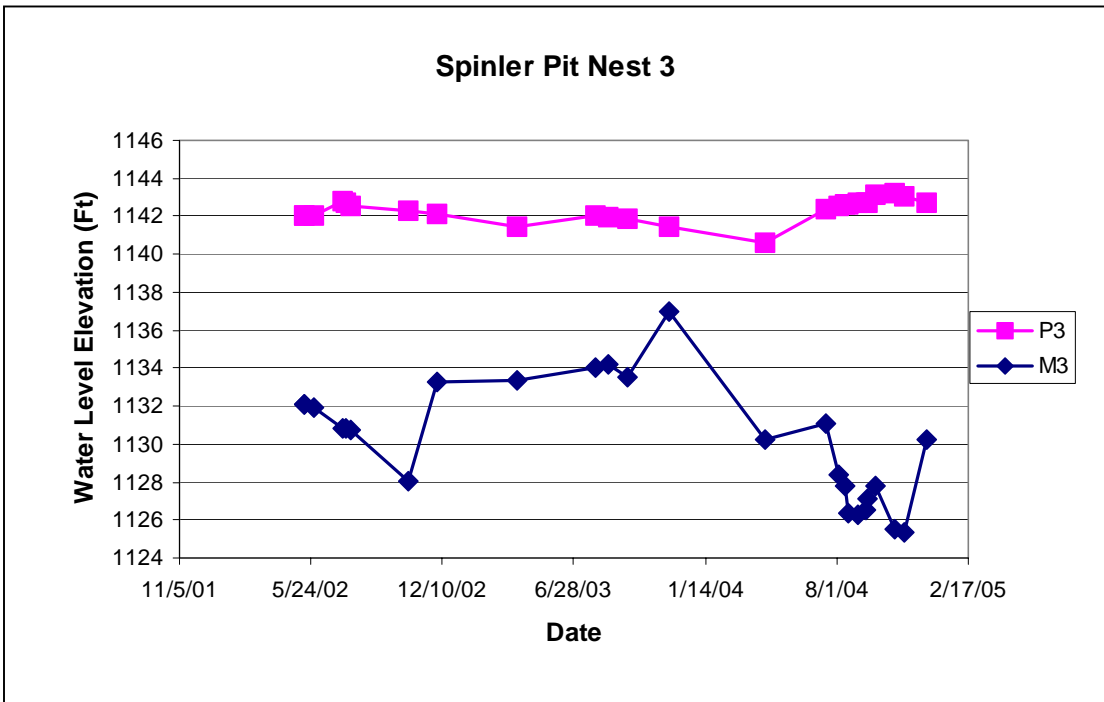

Figure 5.4. Seasonal variation of water levels in Spinler well nest 3.

The ground-water levels at the site on September 15, 2004, were fairly representative of levels in late summer (Figure 5.5). Ground water flows from the surrounding areas into the pit; the ground-water model indicates that a portion of the flow from the Straight River is pirated by the quarry. Stream gaging was completed on the Straight River both upstream and downstream of the pit, and the differences were within the measurement error of the equipment. Results of stream gaging indicate that the loss of water from the river at this time is minimal.

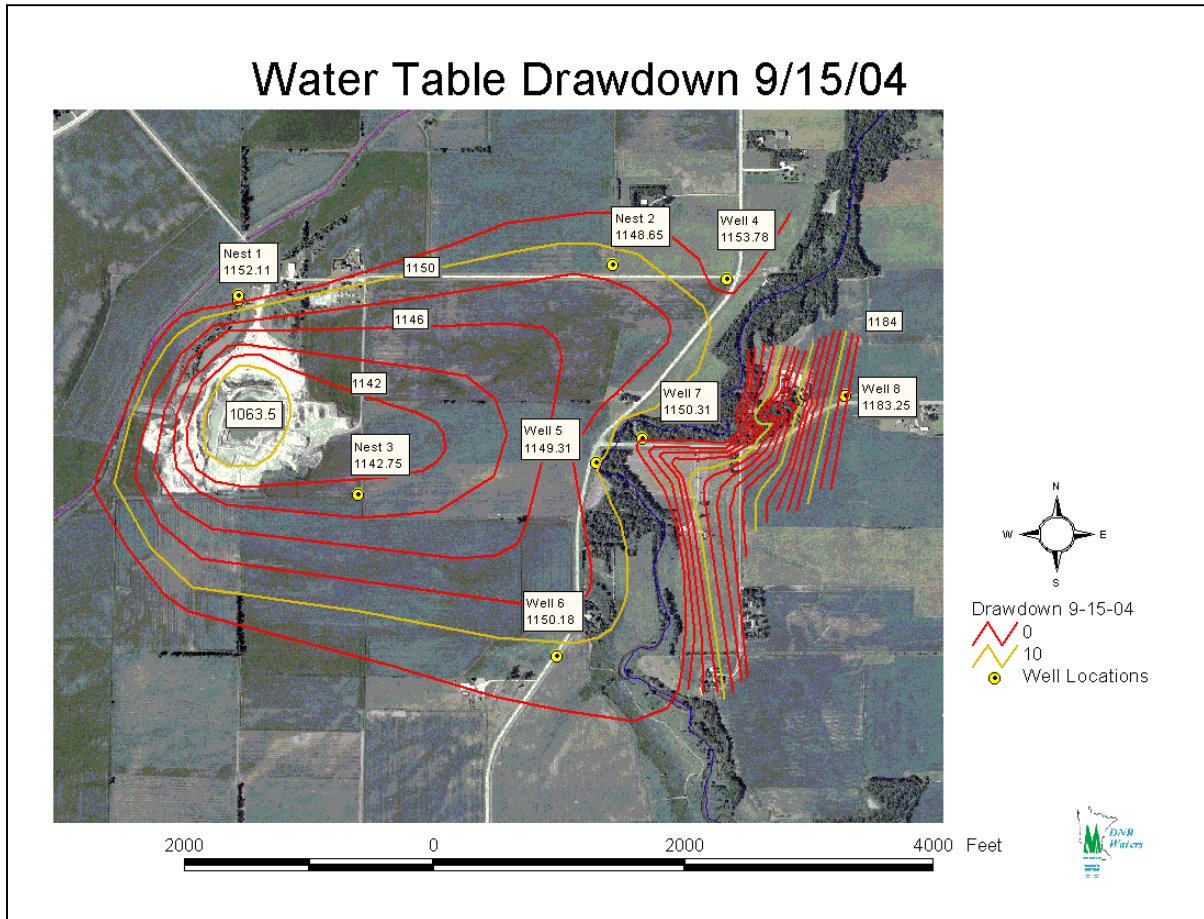

Figure 5.5. Water levels at drawdown in Spinler quarry wells.

Ground-water levels measured June 1, 2005, show a much different scenario (Figure 5.6). The company apparently had allowed water levels within the quarry to rise to nearly normal levels. The water level was still depressed in the vicinity of the quarry, but there was much less water coming from the direction of the river.

Since water levels have risen in the quarry and the lower aquifer, the lower aquifer has changed from being recharged by the upper aquifer to discharging to the upper aquifer in the vicinity of the quarry.

Water Table Drawdown 6-1-05

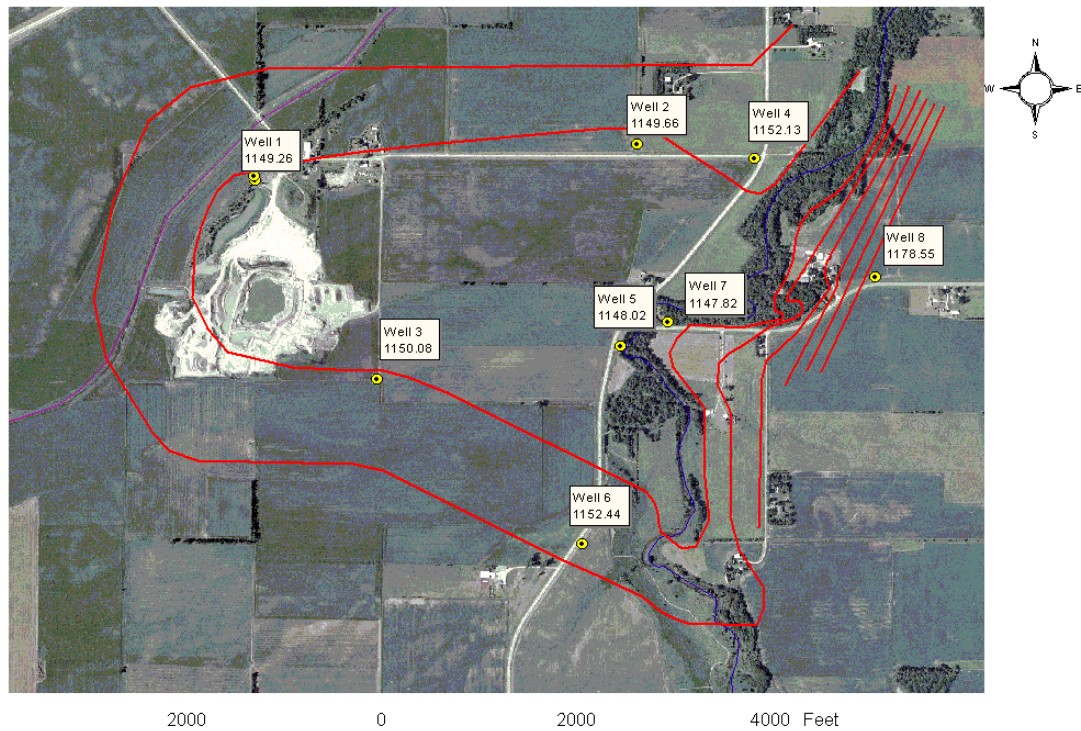

Figure 5.6. Water levels in Spinler quarry, 2005.

Historically, water levels in the upper aquifer in the vicinity of the pit have been about 1155 ft above mean sea level, about 10 ft above the current level being maintained by quarry pumping (Figure 5.7). Prior to farming and quarrying activities, water levels were probably just below the ground surface; however, ditches were dug throughout the area to lower the water table and improve crop productivity.

Due to the complex site geology and hydrology, additional analysis of the impacts of the quarry and its dewatering was done using three-dimensional software. Those results are presented in Appendix 2.

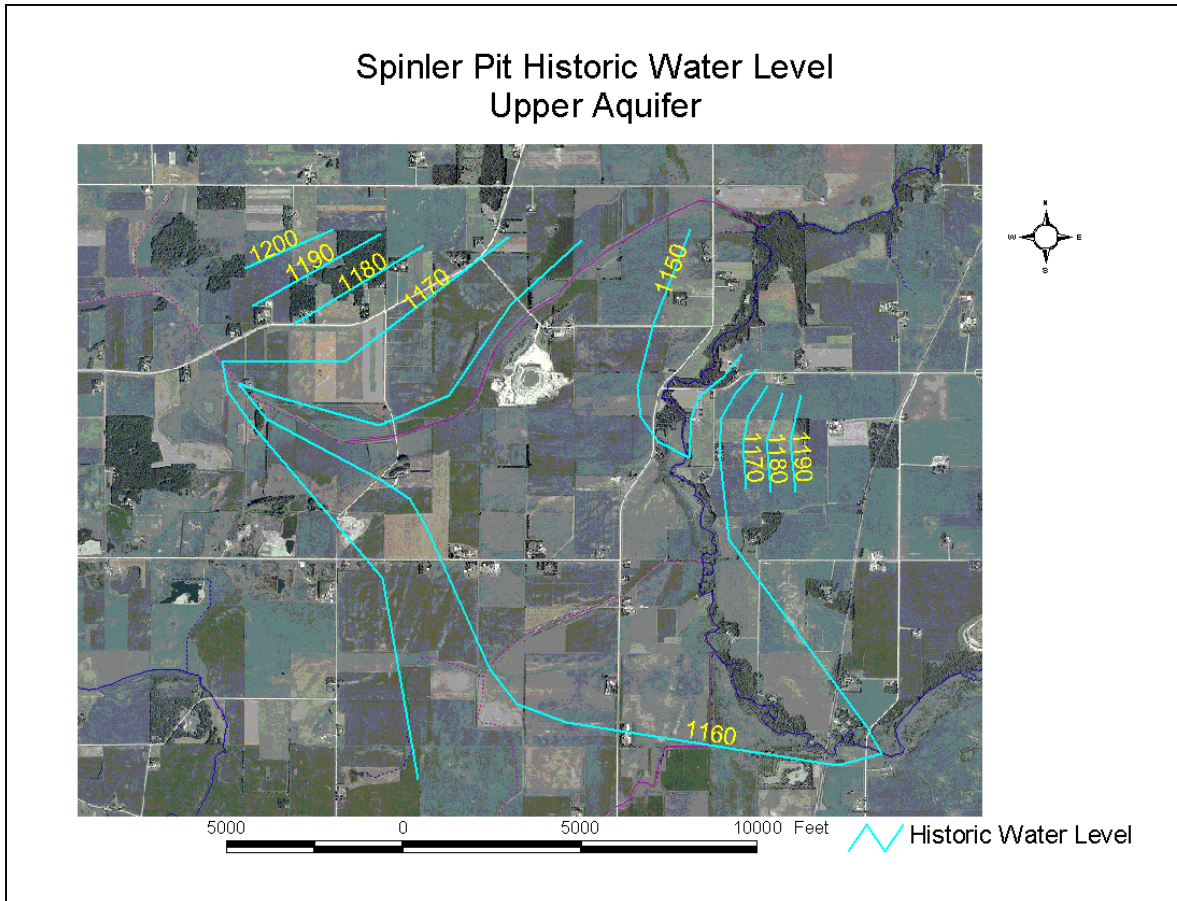

Figure 5.7. Historic water levels in upper aquifer, Spinler Quarry.

Spinler Quarry Downhole Camera

Equipment breakdown prevented the videologging of these wells prior to the conclusion of the project.

Conclusions

Quarrying operations have penetrated two aquifers. Ground-water pumping has changed the hydraulic gradient in the vicinity of the quarry. The lower water levels could affect domestic wells in the immediate area. With ground-water levels dropping, water is flowing from the Straight River into the upper aquifer; historically, the river gained water from the local ground-water system.

SECTION 6. FOUNTAIN QUARRY—GALENA LIMESTONE

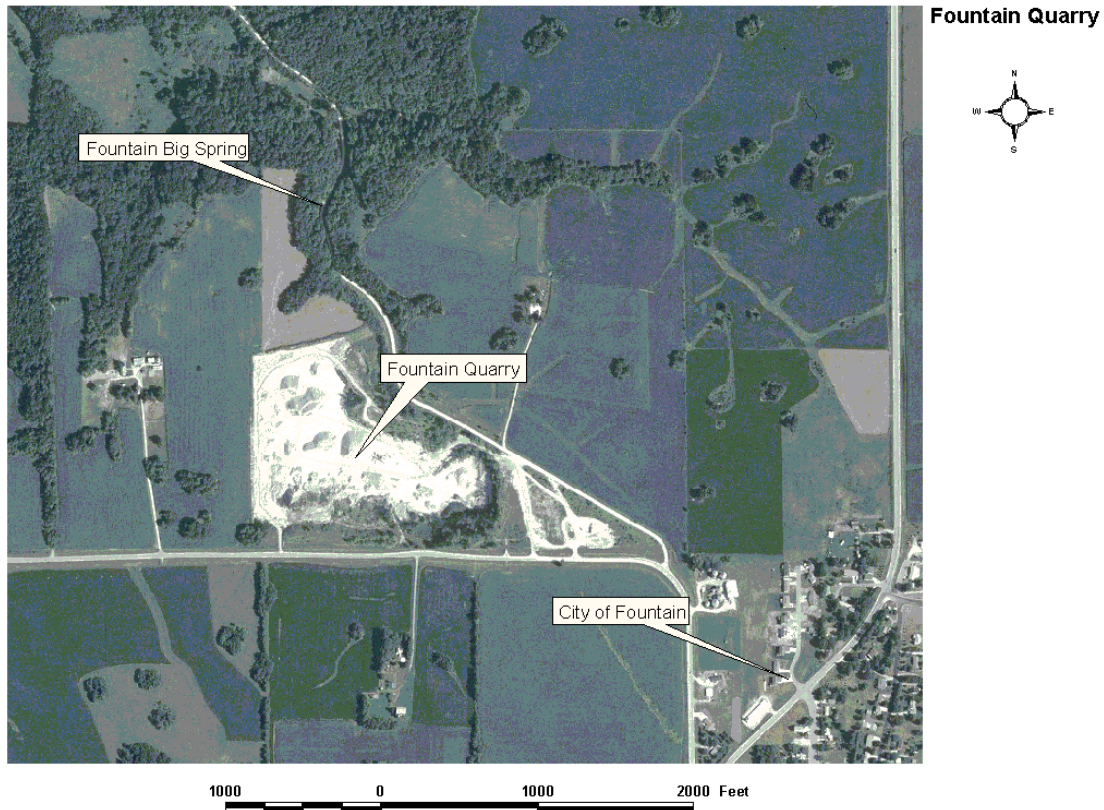

Figure 6.1. Site by aerial photograph.

Fountain quarry operations normally take place above the water table although the quarry (Figure 6.1) occasionally floods from ground water discharging into it from the conduits below. In the quarry, there are four open joints in the floor. These joints have water flowing through them except during the driest parts of the year. Prior to this project, the University of Minnesota Department of Geology and Geophysics, in cooperation with DNR Waters, demonstrated by dye tracing that these joints connect to the nearby Fountain Big Spring on Riceford Creek. During this project, turbidity levels in the spring were monitored to assess the impact of dry quarry operations and blasting events.

Turbidity Impacts

Previous Investigations

Several hundred yards north and west of the Fountain quarry lies the Fountain Big Spring complex (Figure 6.2). These springs are the discharge point for the Fountain springshed. Water sinks in the uplands in sinkholes and through the soil mantle and flows through fractures and solution-enlarged conduits to the springs. The Fountain Big Spring is part of a complex of four springs that has a mapped springshed of approximately 2900 acres. This basin was delineated by

dye tracing work for the Fillmore County Geologic Atlas; the longest straight-line dye trace was from a sinkhole 2.9 miles from the spring complex.

Prior to this study, the University of Minnesota Department of Geology and Geophysics, in cooperation with DNR Waters, ran a dye trace from a joint in the quarry floor to the spring. The dye was poured into a flowing stream at the base of the joint in the east end of the quarry. Prior to the trace, background direct water samples were taken at the spring to check for natural fluorescence. After the dye was poured into the conduit, University of Minnesota students took direct water samples at the spring every 15 minutes for 24 hours. The concentrations of those samples were analyzed with a Turner filter fluorometer. The dye took approximately 12 hours to travel 1900 ft in straight-line distance to the spring (E.C. Alexander, Jr., University of Minnesota, oral commun., 2005).



Figure 6.2. Fountain Big Spring.

Project Investigations

During our project studies, the discharge of the Big Spring was monitored for turbidity changes from blasting events at the quarry. Two blasting events were captured: one with a Global Water WQ series handheld turbidity meter and the second with a Global Water WQ series turbidity sensor, which was left in the spring. Additional blasts were measured with a Greenspan TS series turbidity sensor, but equipment failure prevented data retrieval. A weather station was installed at the quarry to measure precipitation falling on the quarry floor.

On November 4, 2002, Milestone Materials Division of Mathy Construction blasted rock on the west end of the Fountain Quarry. DNR staff at the Big Spring using a handheld turbidity meter made measurements prior to the blast, for approximately 2.5 hours after the blast, and the next day. Results in Figure 6.3 indicate that the turbidity level in the spring increased rapidly after the

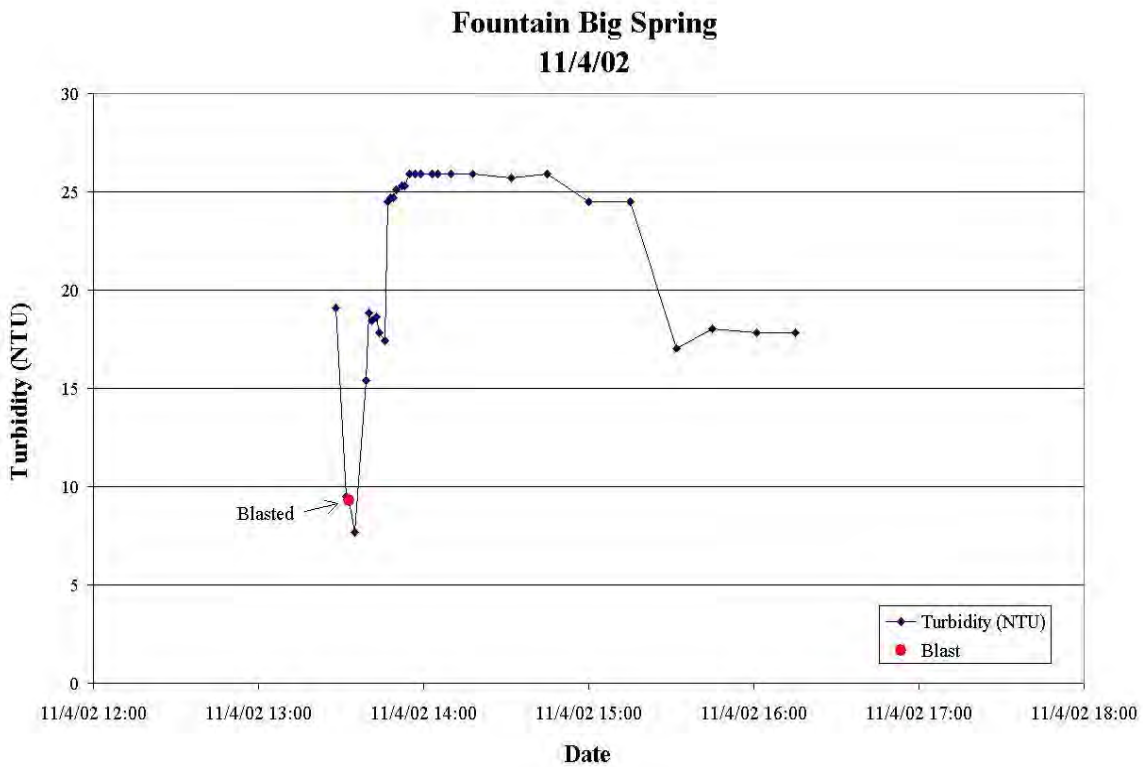

Figure 6.3. Fountain Big Spring turbidity after November 4, 2002 blast.

blast. In the first 20 minutes after the blast, the turbidity level more than tripled. Based on the ground-water travel time from the dye tracing work, this increase was not due to material moving from the quarry. Our explanation is that the shock wave from the blast put fine sediment in the conduit system into suspension. This suspended material then moved through the conduits and was discharged at the spring.

On October 5, 2004, another blast on the west end of the quarry was captured with a Global Water WQ series turbidity sensor. The instrument was programmed to read turbidity every 15 minutes. Approximately 1.5 hours after the blast, the turbidity level increased by 4 nephelometric turbidity units (NTUs) from 23 to 27 (Figure 6.4). The turbidity peaked at 32 NTUs 7.5 hours after the blast. The level dropped back down to 27 NTU and then went back up to approximately 32 NTU. Our explanation for this event is similar to that of the November 4, 2002 blast. Material in the conduit is shaken loose and transported by turbulent flow to the spring.

Fountain Big Spring Turbidity

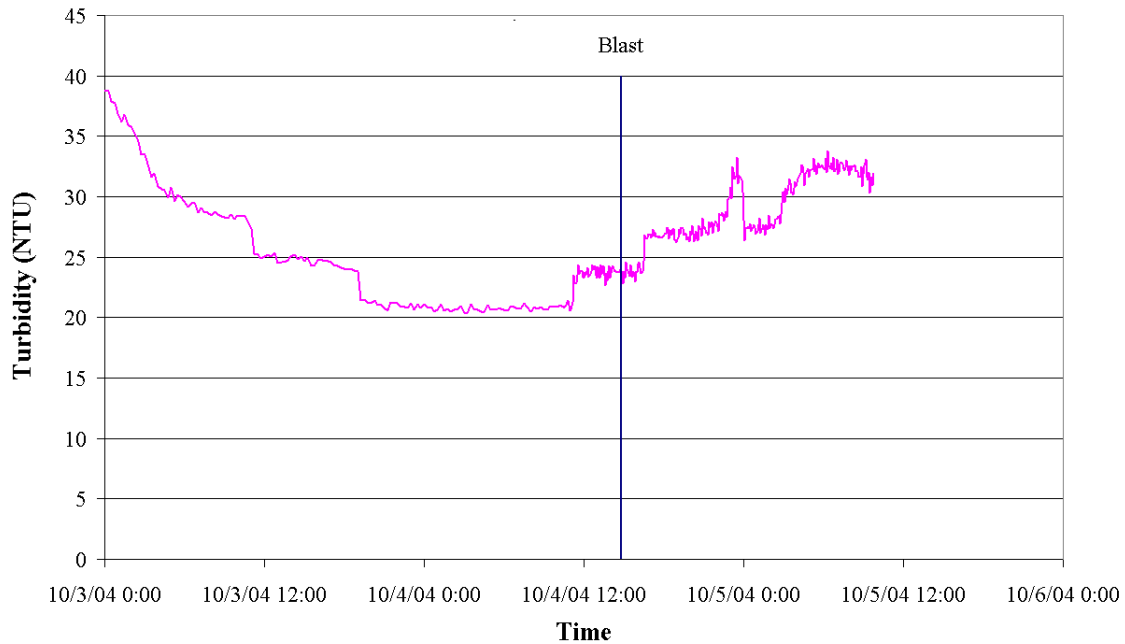

Figure 6.4. Fountain Big Spring turbidity after October 5, 2004 blast.

Before it was stolen, the Greenspan TS series turbidity sensor recorded turbidity changes during spring from rain events (Figure 6.5). Several large rainfall events provided the opportunity to study the effects of precipitation on turbidity. The majority of the precipitation events caused the turbidity to rise between 12 hours and 16 hours following the onset of precipitation; however, when the system was primed by antecedent rainfall, the effect could be seen in less than 6 hours. Most increases in measurable turbidity were on the order of 10 NTUs, but the largest events increased the turbidity above 600 NTUs. The true magnitude of these events is unknown because the maximum turbidity exceeded the upper measurement limit of the turbidity sensor. In general, the response from precipitation is much larger than the response following blasting.

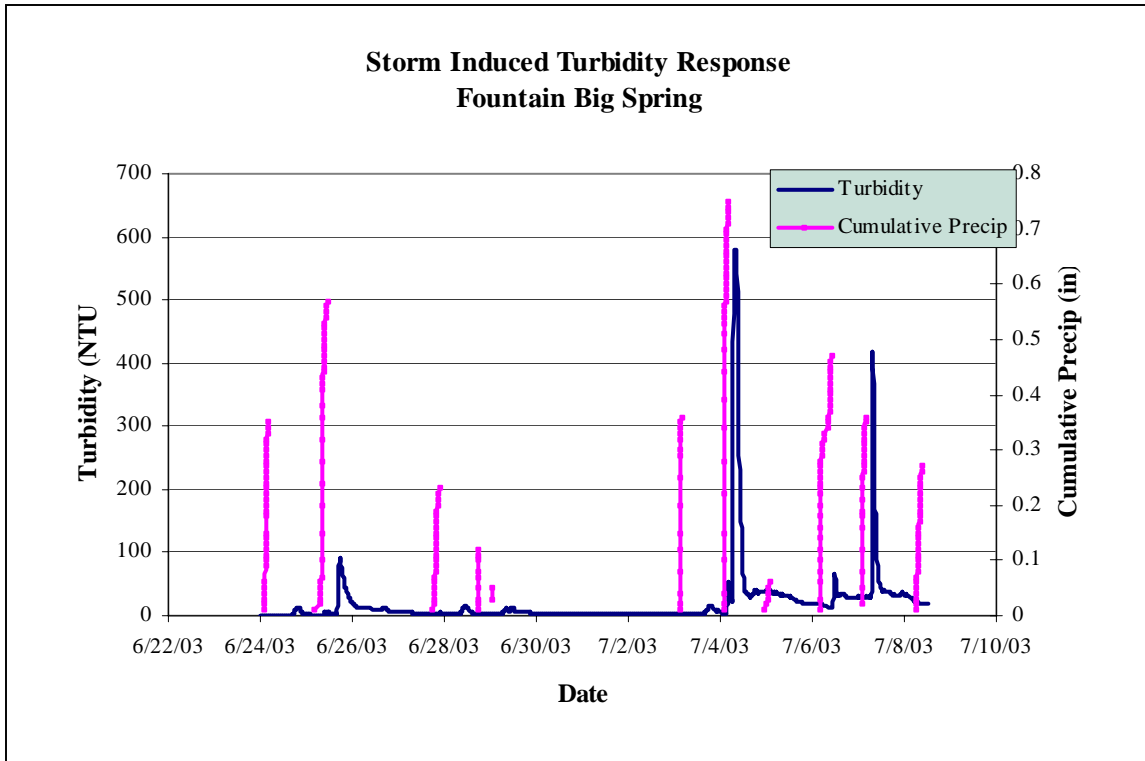

Figure 6.5. Fountain Big Spring turbidity response to rain.

Conclusions

The turbidity data indicate an impact from blasting on the water flowing through the conduit system to the spring. Based on our knowledge of ground-water travel time in this system, this material comes into suspension in the limestone's joints and fractures because of the blasting. Essentially, the shaking of the rock causes some fine-grained material to go into suspension where it is already present, then the material is carried to the spring. This same mechanism could also provide for turbidity spikes in domestic wells. Those wells would need to be finished in the surficial limestone layer and be open to solution-enlarged joints and fractures with significant flow. This describes many wells completed in southeastern Minnesota before enactment of the state well code; typically, owners of those wells have complained about the effects of blasting. These types of wells need to be considered when evaluating other quarrying operations in limestone terrains. Another mechanism of blasting-induced turbidity in domestic wells is the shaking of precipitates from the inside of the casing.

Normal quarrying operations above the water table did not appear to increase turbidity in the Big Spring. Precipitation events can also increase turbidity in the conduit system; at this site, those impacts were much larger than those of blasting. In the case of a domestic well owner complaining about turbidity from blasting, this effect would also need to be monitored.

SECTION 7. HARMONY BIG SPRING QUARRY—GALENA LIMESTONE

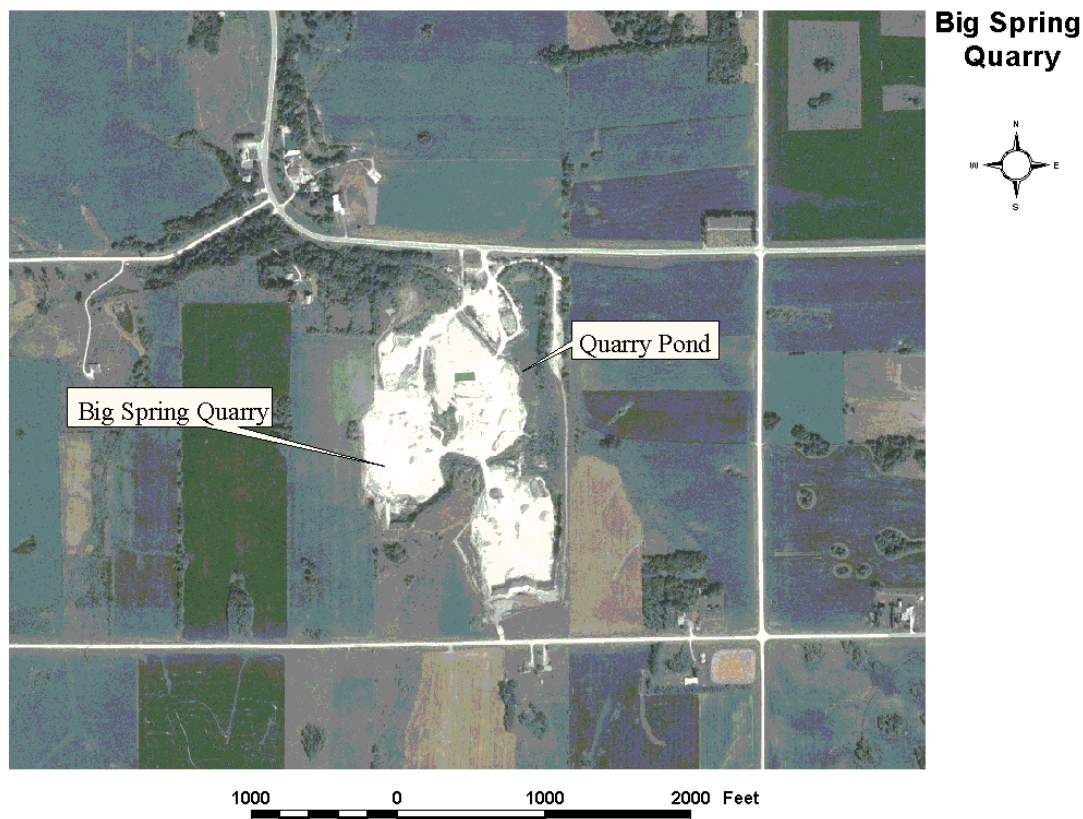

Figure 7.1. Site by aerial photograph.

Previous Investigations

Dye traces were conducted in the area as part of the Fillmore County Geologic Atlas mapping effort (Alexander and others, 1995) by the Minnesota Department of Natural Resources. This work was an attempt to map the basins feeding some of the large springs in the county. Boundaries between the Big Spring basin and other basins were partially established during this project. The Big Spring basin lies between the Odessa basin to the south, the Engle Spring basin to the west, and the Hart Spring and Buggywhip Spring basins to the east. During this research, we knew that we had not located all of the basin boundaries nor had we dye traced from the sinkhole plain area that extends north and east from the quarry site (Figure 7.1).

Project Investigations

Impacts on Ground-Water Flow Paths

As part of this research project, we have been using dye tracing to refine the existing basin boundary map and determine how much of the basin area is being routed through the quarry (Green and others, 2003). Tracing was also done in the quarry to determine internal flow paths. The internal traces were run from sinking points on the west and east sides of the quarry. The trace from the west side, done under high-flow conditions, demonstrated that water sinking in the southwest part of the quarry emerges at the Big Spring. Because this trace was done under high-

flow conditions, some of the water and dye returned to the surface in the quarry itself. Under normal- and low-flow conditions, water does not return in the quarry. Water on the east side of the quarry discharges primarily from spring A238 (Big Spring East). The water flows into a pond where some of it sinks into a stream sink, B11, in the bed of the pond. A dye trace from the pond confirmed that water does sink in the bed of the pond; the water that does not sink flows out of the quarry in a surface stream that joins Camp Creek. Dye traces were also run from four upland sinkholes. These traces were performed to further refine the boundaries of the Big Spring basin and document the extent of the basin area that has been pirated by the quarry. The rate of ground-water movement during these traces was 1,635 feet per day to 3,270 feet per day. The results of the tracing are shown in Figure 7.2.

The quarry has had a profound impact on the local ground-water flow system. Based on the 1995 springshed map in the geologic atlas and the additional tracing work done as part of this project, approximately 90% of the flow in the Big Spring basin is now being routed through the quarry. This exposes the conduit water to thermal impacts and makes it more vulnerable to pollution from quarrying activities.

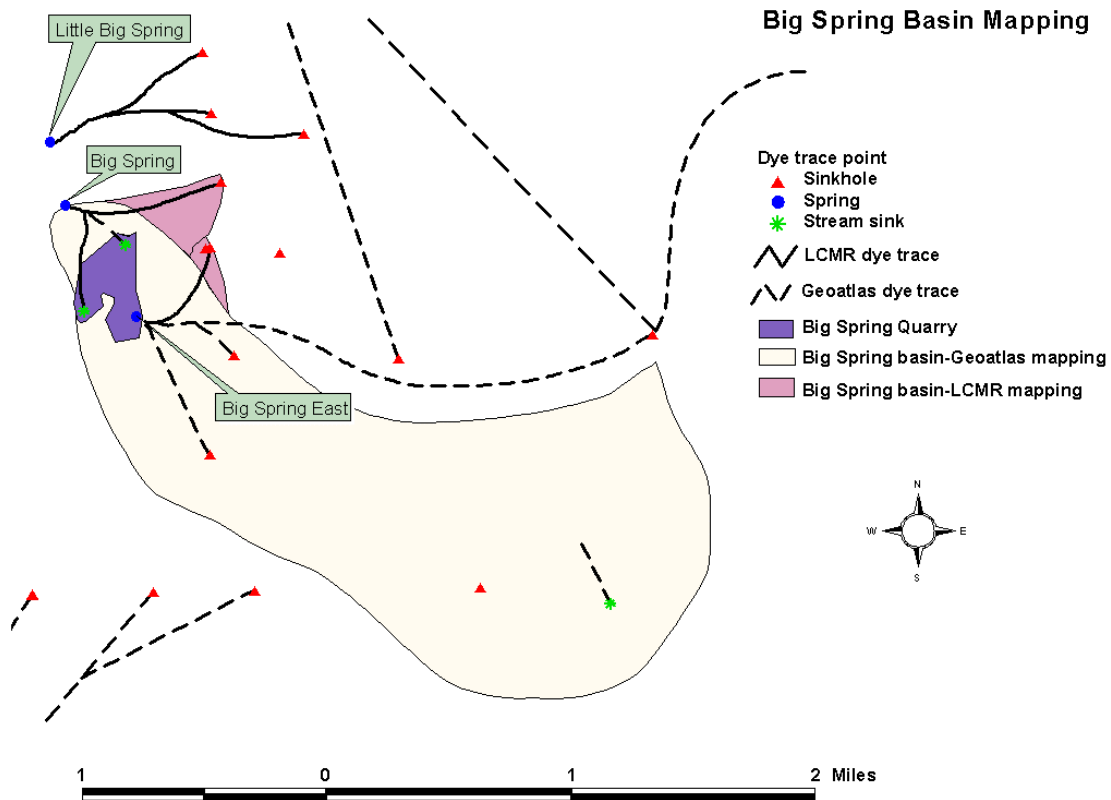

Figure 7.2. Springshed dye trace map.

Impacts on Water Temperature

The impact of the conduit piracy on water temperature was also a concern. Trout are a cold-water species and, as noted previously, Camp Creek is a designated trout stream. In order for a stream to be considered cold water, the long-term temperature maximum cannot exceed 70 degrees Fahrenheit (F) (21 Celsius [C]). Peak daily temperatures cannot exceed 75 F (23.8 C). If these thresholds are exceeded, the stream will not be able to sustain a viable trout population. Through this project, we have begun to document the quarry impacts on the spring and stream.

A round of temperature measurements was taken July 15, 2003, to begin quantifying the thermal impacts on the ground-water system. Figure 7.3 shows the results of that monitoring. Water emanating from A238 (the main discharge point on the east side of the quarry) was about 49 F (9.3 C). As it flowed through the quarry and into the quarry pond, it warmed to a measured maximum of about 70 F (21.3 C). The water flowing out of the quarry via the surface stream was about 64.5 F (18.6 C) (several other springs in the quarry also discharge to this stream). The temperature of Big Spring, the headwater spring of Camp Creek, was about 56 F (13.6 C). In contrast, Little Big Spring, which has not had its basin pirated by the quarry, was 48.2 F (9 C). The warming of the water at the stream's headwater spring could have significant impacts on the stream's ecosystem.

Project funds have been used to purchase thermochrons (button-size temperature recorders); they will be used to continue the thermal impact monitoring at this site after the project ends.

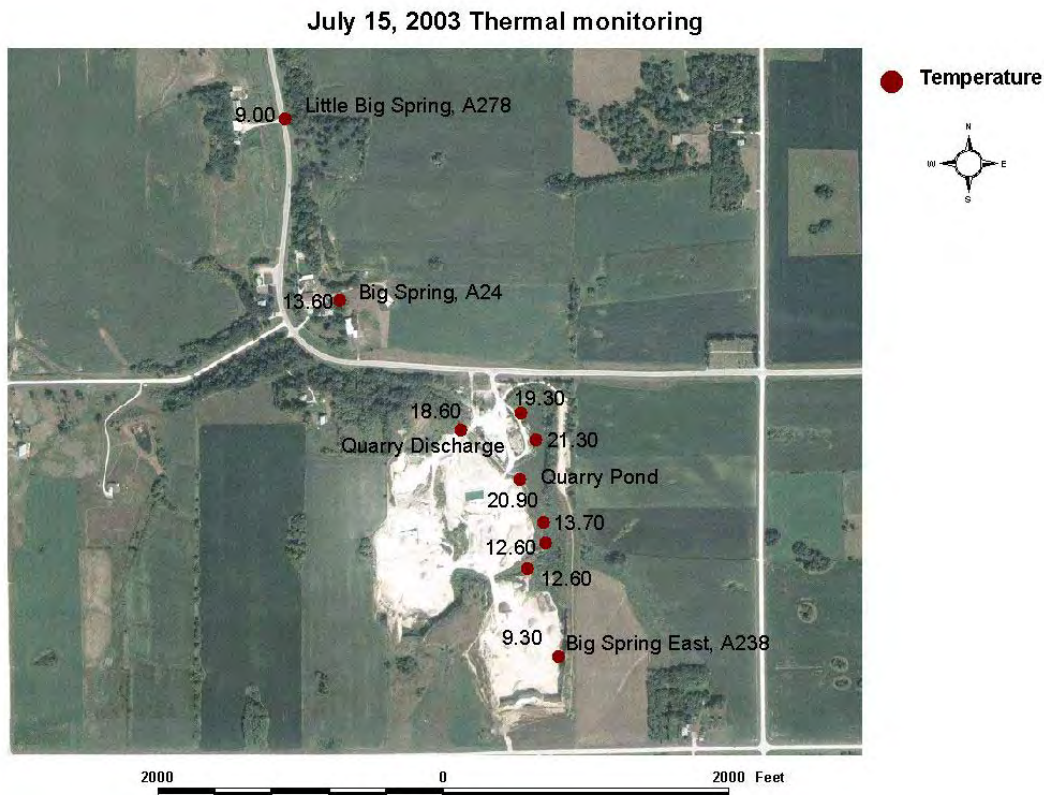

Figure 7.3. Temperature (degrees Celsius) monitoring results.

Conclusions

By using dye tracing, we were able to document and quantify the scope of spring piracy at the Big Spring quarry. Based on available information, roughly 90% of the basin is now being routed through the quarry. Without any dewatering occurring, this quarry has significantly altered ground-water flow paths. The water surfacing in the quarry is significantly affected by the surface air temperature, changing the thermal regime of the Big Spring and the upper reaches of Camp Creek.

SECTION 8. DONOVAN PIT—ALLUVIAL SAND AND GRAVEL

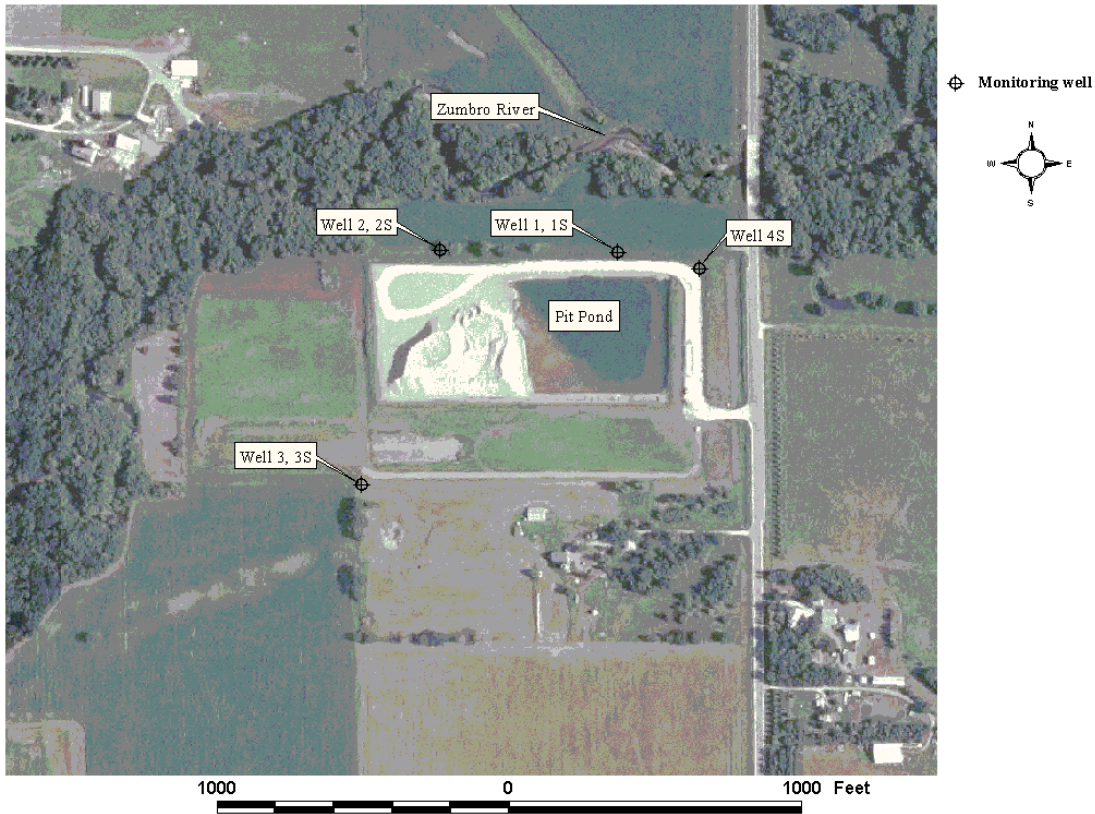

Figure 8.1. Site by aerial photograph.

Monitoring began at the Donovan gravel pit (Figure 8.1) because local residents had expressed concerns regarding the impacts of gravel pits on local ground water. Operations in the pit started working below the ground water in March 2003.

Sand and gravel pits in alluvial settings are vulnerable to flooding. This highlights the importance of good surveys of site elevations and site planning before a pit opens. These preparations will help prevent flooding from inundating equipment and buildings on the site. Floods in May 2003 and September 2004 overtopped the banks of the Zumbro River and flooded the Donovan pit (Figure 8.2). These events resulted in ground-water levels rising more than 6 feet; however, at the peak, the floodwaters were much deeper and had completely flooded over the wells.



Figure 8.2. Floodwaters in the Donovan Pit in 2003.

Impacts on Water Levels

Mining below the water table in the pit has done little to affect the quantity of water flowing to the Zumbro River (Figure 8.3) and has not affected upgradient domestic wells (Figures 8.4a, b, c, d based on an assumed datum of 100 ft). In areas of complex stratigraphy with abundant clay and a high topographic gradient, the loss of sand and gravel possibly could affect ground-water levels substantially; however, alluvial deposits are not very likely to have the significant deposits of clay and the topographic gradient is slight.

The open water does increase the possibility of ground-water contamination if a spill were to occur. The ground water is only about 6 feet below the ground surface, so if a spill were to occur on land, it could contaminate the ground water because 6 feet does not allow enough time to remedy the contamination.

Donovan Pit Ground Water Elevations 4/28/04

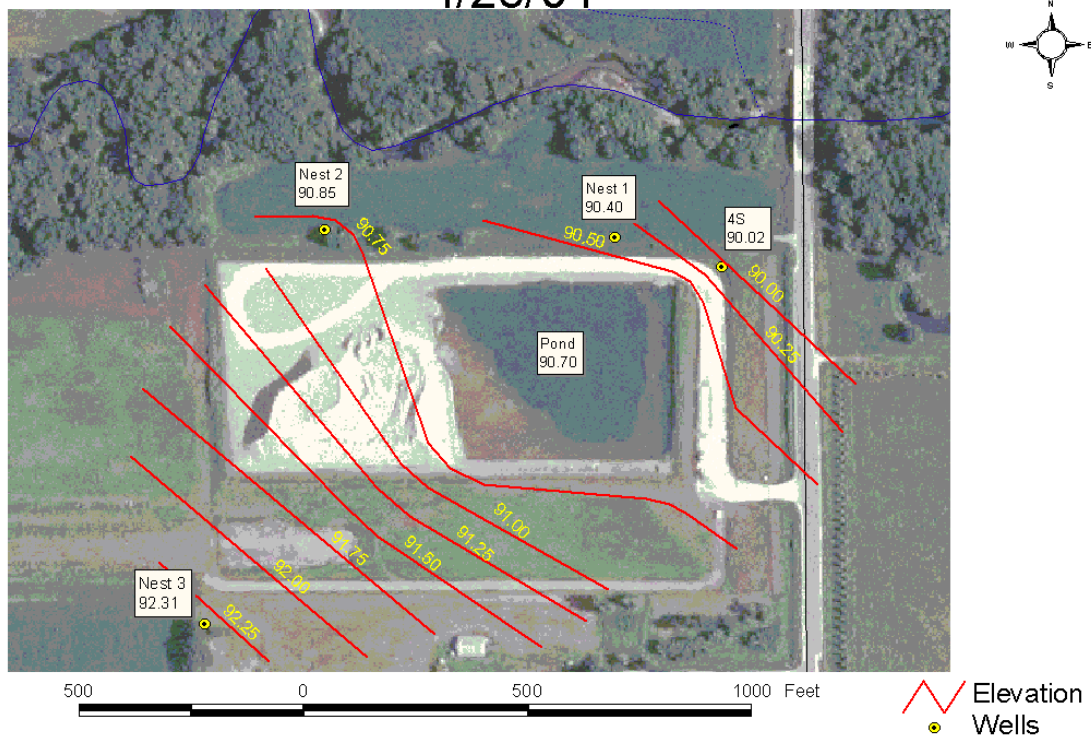

Figure 8.3. Ground-water levels in the Donovan pit.

Donovan Pit Nest 1

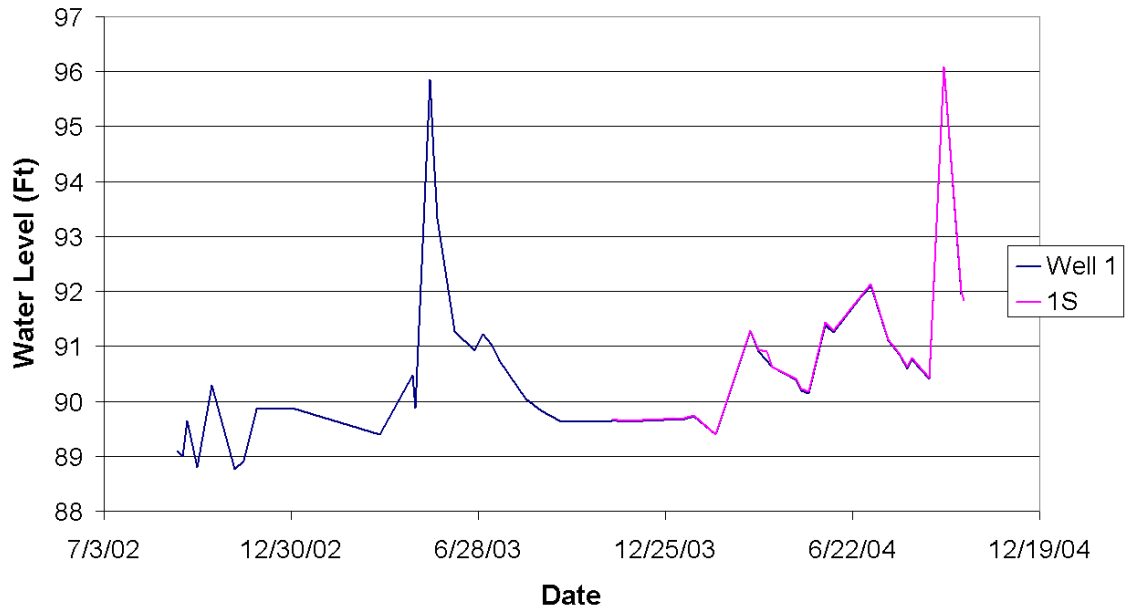

Figure 8.4a. Water levels, nest 1.

Donovan Pit Nest 2

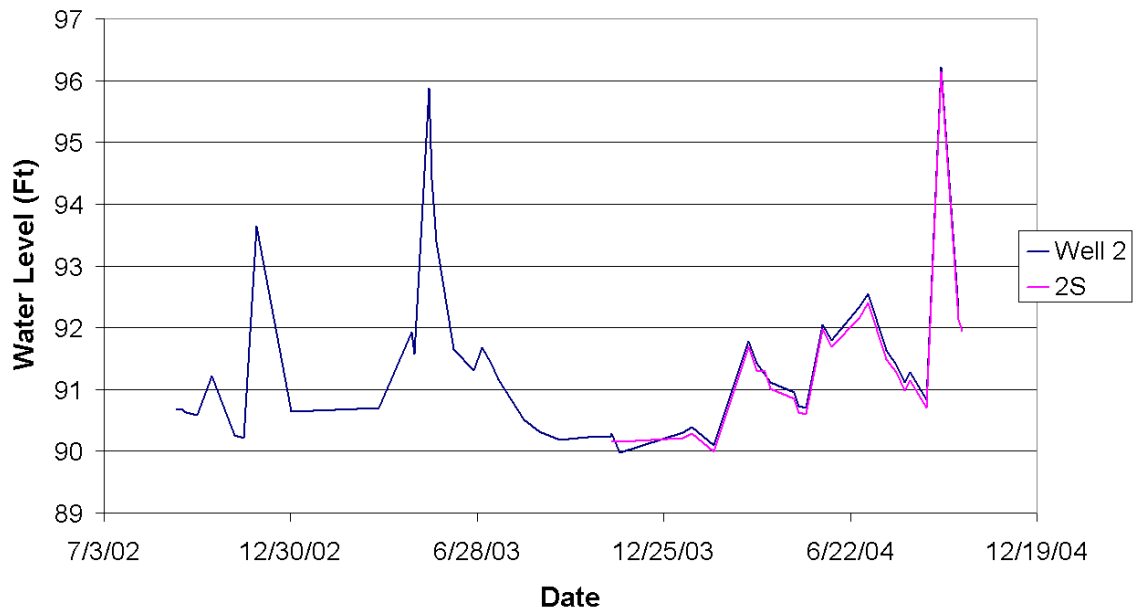

Figure 8.4b. Water levels, nest 2.

Donovan Pit Nest 3

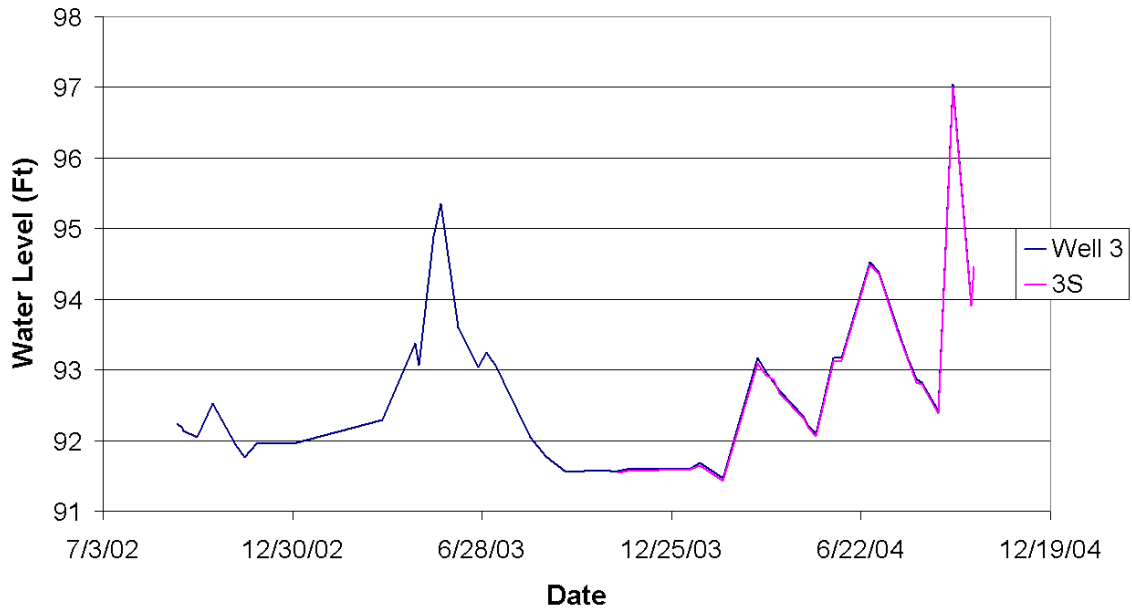

Figure 8.4c. Water levels, nest 3.

Donovan Pit 4S

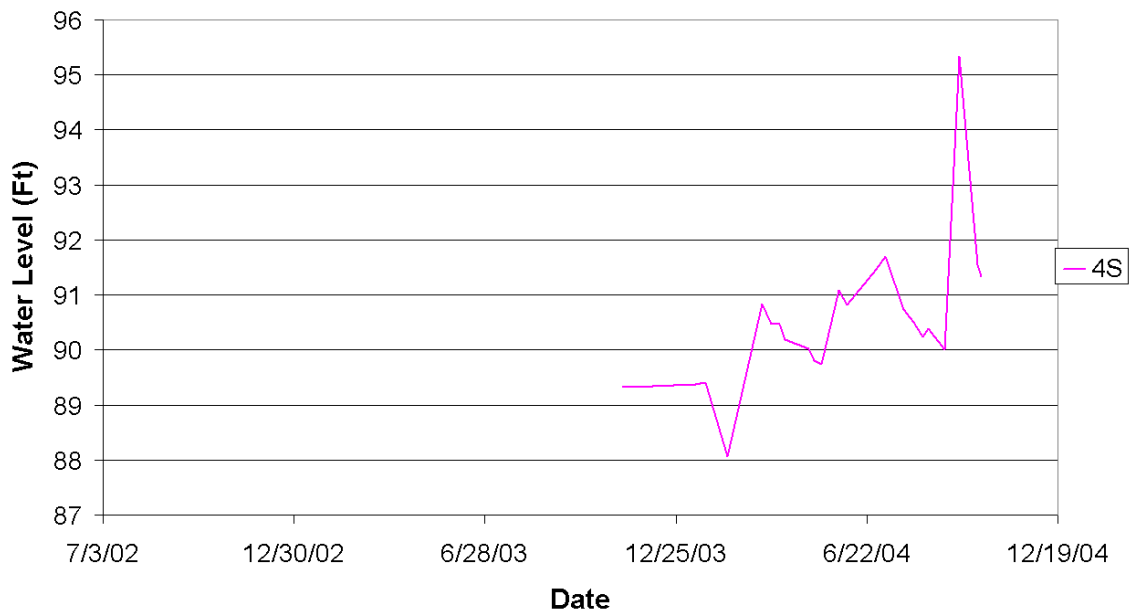

Figure 8.4d. Water levels, nest 4.

Impacts on Water Temperature

Early in this project, the monitoring at this site focused on the influence of the pit pond on ground-water levels and ground-water quality. As the project progressed, the focus shifted to the thermal impacts of the pit pond on ground-water temperatures in the sand and gravel aquifer and the influence that had on the thermal characteristics of the Zumbro River. This change resulted after DNR Ecological Services voiced concerns about the impacts of mining on threatened mussel species that had been found during biological surveys of the Zumbro River in this area.

In order to assess the thermal impacts, project staff began measuring water temperatures in the pit pond and the four shallow monitoring wells at the site. Ground-water temperatures in southern Minnesota typically are fairly stable at approximately 48 F. Data displayed in Figure 8.5 indicate there are significant fluctuations in ground-water temperature in the wells onsite. However, there was no apparent pattern to the variations. Wells 2S and 3S are upgradient of the pit while wells 1S and 4S are downgradient. Since we could not draw any conclusions from this monitoring, staff purchased thermochrons (button-size temperature monitors) to deploy into the wells, pit, and river in order to continue this monitoring after the project concluded. These devices can measure the temperature fluctuations with minimal maintenance. They are designed to be left in the field year-round and will provide a more comprehensive picture of the thermal impacts of this pit.

To enhance future thermal modeling efforts, project staff also directly measured ground-water time of travel in the sand and gravel deposit using a ground-water tracer. Using the observation well water level data and the water surface elevation of the pond, staff were able to determine the relative ground-water flow direction in the sand and gravel. Initially, project staff intended to pour a fluorescent dye into the pit pond and use well 2, 2S, and 4S as sampling points. After further review, that idea was abandoned, as there was no guarantee that the dye plume from the pond would intersect with the wells.

Subsequently, staff decided to use open trenches in the water table perpendicular to the ground-water flow direction for dye injection and sampling. The trenches were excavated with a backhoe by Milestone Materials Division of Mathy Construction. Uranine C was poured into trench 1 (Figure 8.6); water samples were taken from trenches 2 and 3 daily. Six days after dye input, trench 2 had visible dye (Figure 8.7). The concentration visibly increased over the next several months. Sampling continued for several months after dye injection; no dye was detected in trench 3. Sample analysis was performed with an Aquafluor handheld fluorometer. In late December 2004, project staff had Milestone Materials staff fill the trenches so they would not remain open all winter and pose a safety hazard.

Donovan Gravel Pit Shallow Monitoring Well Temperatures

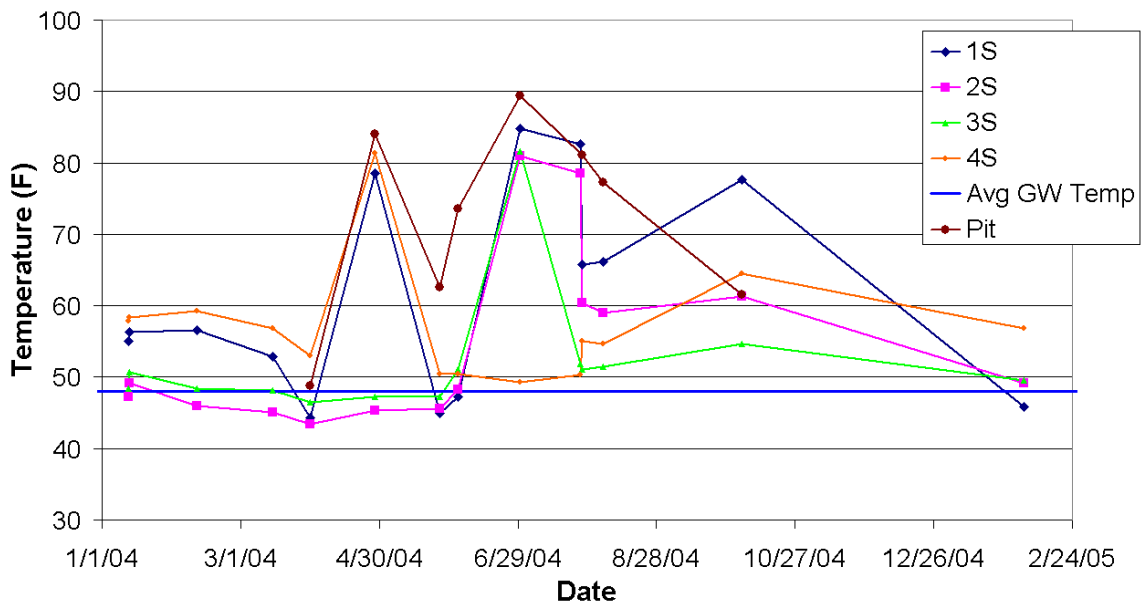

Figure 8.5. Fluctuations in ground-water temperatures.



Figure 8.6. Trench 1, dye injection point.



Figure 8.7. Trench 1 (left) and trench 2 (right) dye sampling point.

Conclusions

Fluctuations in ground-water levels were observed in the monitoring wells onsite. There is no evidence that these fluctuations were due to mining activities. Based on the available data, the fluctuations resulted from precipitation events and are part of the normal response of a surficial aquifer to climatic variations. Temperature monitoring in the wells was inconclusive because of the sporadic nature of the monitoring.

The breakthrough curve for the dye trace is displayed in Figure 8.8. The dye plume did not intersect with trench 3, but the dye broke through to trench 2 in 80 to 100 hours based on the increase in dye concentrations. That indicates a ground-water travel time of approximately 1 ft per 10 hours or 2.5 ft per day. This is a reasonable value for a sand and gravel aquifer. Prior to the dye trace, project staff had measured water levels in the shallow wells and pond and had determined the ground-water elevations at each site with an assumed datum. This allowed staff to determine that the hydraulic gradient at the time of the survey was 0.003 feet per ft; the porosity of a sample of the material at the trench site was 0.27. Putting these numbers into Darcy's equation along with the ground-water velocity gives a hydraulic conductivity of 1683 gallons per square ft per day. This number is well within the range of typical hydraulic conductivity values for an aquifer of this type (Heath, 1984). This value can be used in the future in coordination with the temperature monitoring to model the thermal flux from the pit pond to the Zumbro River.

The dye did not break through to trench 3. Further investigation at the site by DNR Waters staff could not find any type of fine-grained sediments between trench 2 and trench 3 that would have slowed the ground-water velocity. Staff concluded that the dye plume traveled past the trench on its way to the Zumbro River.

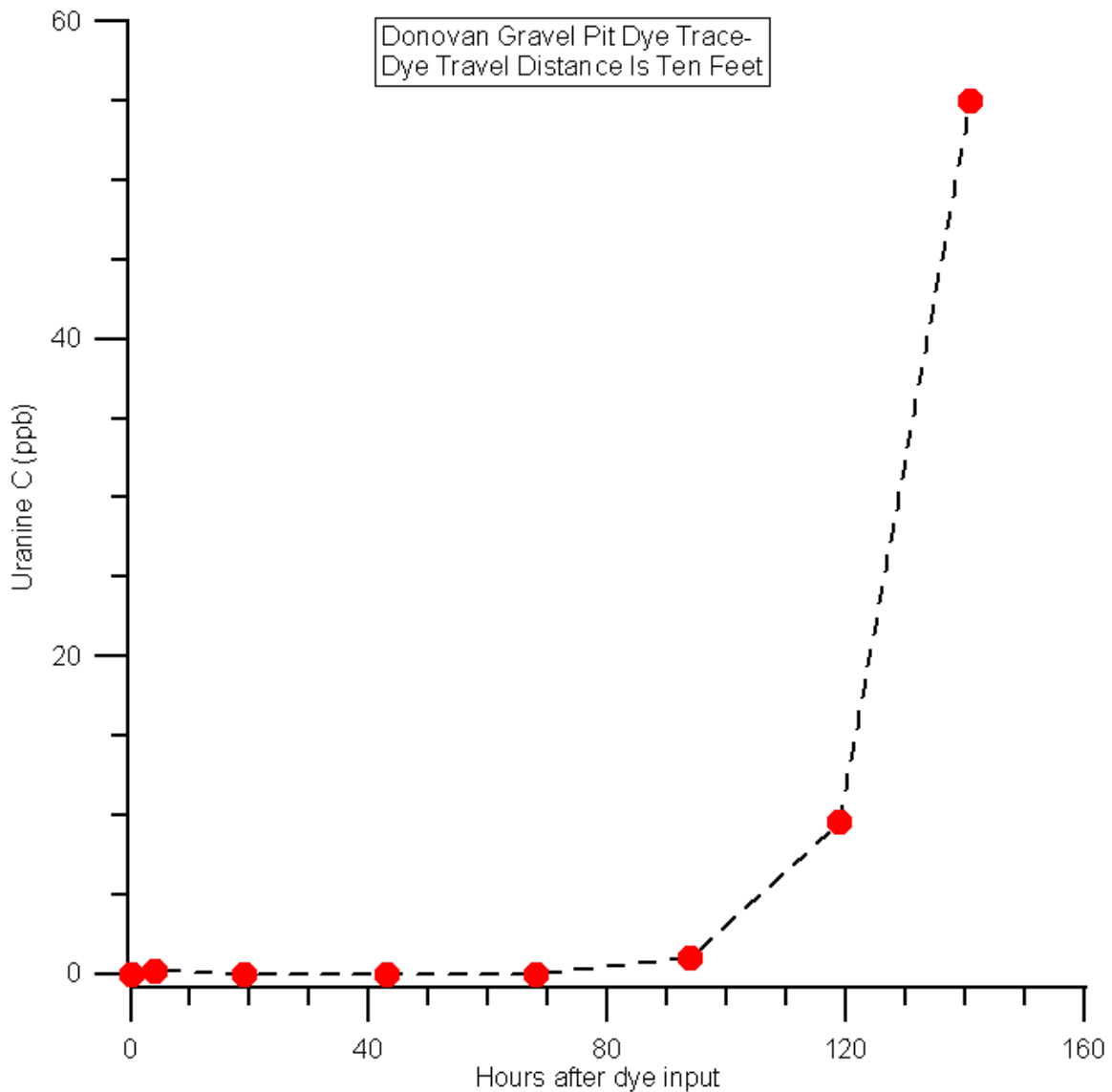

Figure 8.8. Breakthrough curve for the dye trace.

This was the first dye trace in Minnesota where the analysis was performed with a handheld fluorometer (Figure 8.9). This device performed well and allowed rapid analysis of the samples. Without this device, completing the analysis would have required from weeks to months. Having the device and the ability to analyze the samples immediately after they were taken allowed staff to quickly determine the dye breakthrough curve.

Using only visual analysis would have resulted in a slower ground-water velocity being calculated as the dye broke through at 2 orders of magnitude above background levels fully 24 hours prior to its being visible. The device was also very beneficial for the trench 3 monitoring; staff were able to know that the dye had not broken through and were able to end the trace prior to the end of mining activities in the pit for the winter.



Figure 8.9. Handheld fluorometer.

SECTION 9. LEITZEN-GRABAU PIT—ALLUVIAL SAND AND GRAVEL

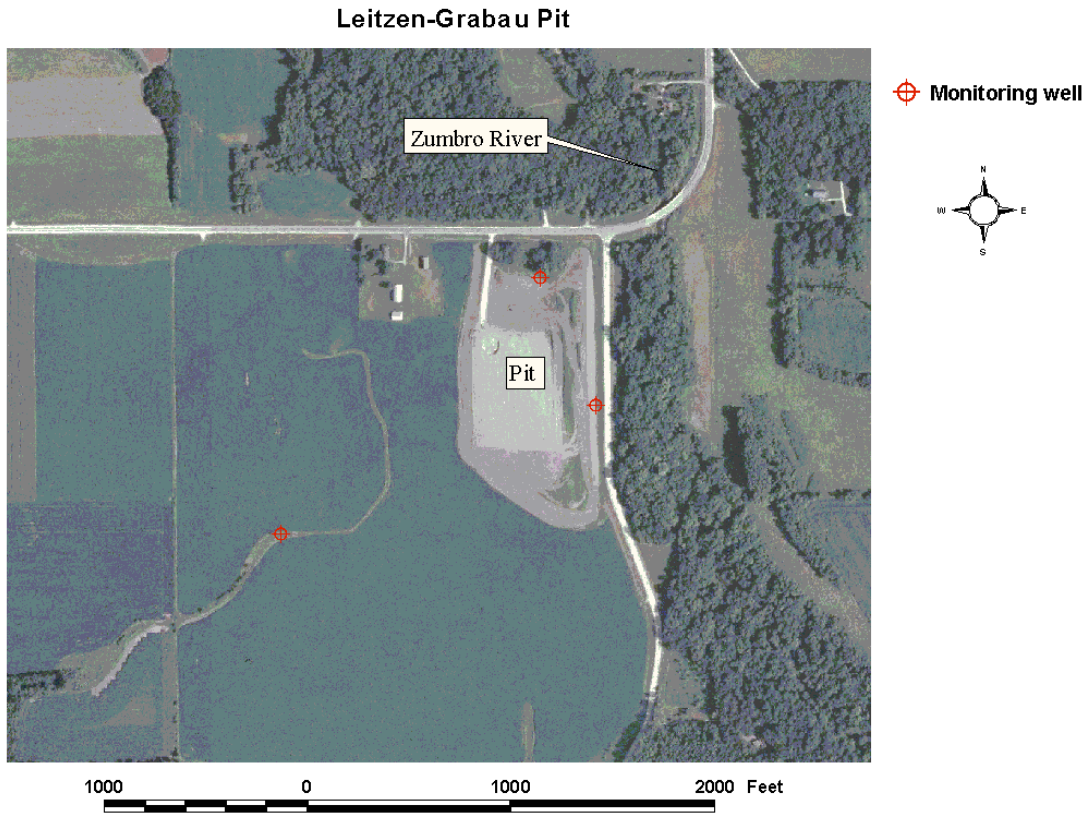

Figure 9.1. Site by aerial photograph.

Monitoring started at the Leitzen-Grabau pit (Figure 9.1) about the same time as at the Donovan pit. Concerns were expressed regarding the impacts of gravel pits on local ground water. At the Leitzen pit, most of the sand and gravel is available above the ground water so excavation significantly below the water table is not necessary.

The peaks in monitoring well 3 (MW3) in 2003 and 2004 (Figure 9.2) are due to heavy rain events and show the natural variability of the ground water in the area. The ground water in the area functions similar to that found in the Donovan pit; however, it is higher on the landscape and above the floodplain. While ponding occurs frequently within the pit, it never floods more than 1 or 2 ft deep. There is no indication that the gravel mining has had any impacts on ground-water levels in the area.

SECTION 10. FELTON PIT—GLACIAL BEACH RIDGE SAND AND GRAVEL

Felton Pit Area

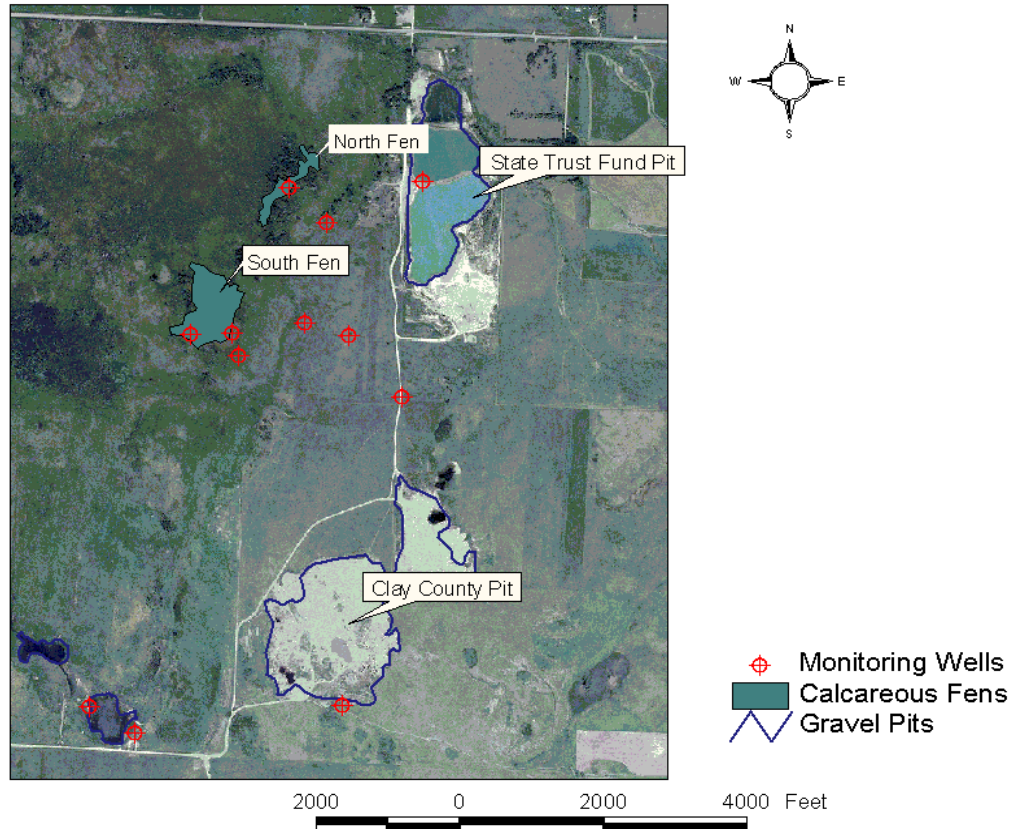

Figure 10.1. Site by aerial photograph.

The Felton study area has several active gravel pits, the largest of which is the Trust Fund Pit (Figure 10.1). The mandate is to earn money for the School Trust Fund. Substantial high-value gravel resources have been identified below the water table in and surrounding the Felton area gravel mines.

Monitoring work in this area was carried out in an effort to understand the impacts of sand and gravel mining on calcareous fen wetlands. Two such wetlands lie to the west of the mines and about 30 feet lower in elevation. Calcareous fen wetlands provide habitat for rare plants and are protected under Minnesota Statute 103G.223. The plants can only exist where there is a constant supply of nutrient-poor, carbonate-rich ground water and there must not be surface water inflows. It follows that mining-induced changes in ground-water and surface-water hydrology may be incompatible with the sustainability of calcareous fen wetlands.

The Felton study area provided an opportunity to study a calcareous fen in proximity to an active gravel mine (North Fen) while a second calcareous fen could serve as a control (South Fen). Mining adjacent to the North Fen had begun in 1959, while basic monitoring began in 1995. Declining quality of the North Fen was recorded in the late 1980s and early 1990s.

As noted in Section 2, ground-water gradients were monitored at well nest locations in and upgradient of each fen. Water levels were monitored at other single-well installations. A staff gage was installed in the Trust Fund Pit to record water levels in the gravel pit lake. Present-day water table elevations were recorded in wells and borings, while evidence of past water levels was noted on the landscape and in wells and borings. Data from exploratory borings, well logs, and geophysical exploration were used to construct geologic cross sections.

The cross sections reveal the subsurface along an approximate east to west trace (Figure 10.2). The North Fen is at the western edge and the Trust Fund Pit at the eastern edge of the A–A' cross section (Figure 10.3), and the South Fen is at the western edge of the B–B' cross section (Figure 10.4). The blue trace of the water table in Figure 10.4 shows that the water table intersects the ground surface along the upper edge of the South Fen, where it still provides upwelling ground-water supply to the whole calcareous fen. The water table in Figure 10.3 intersects the ground surface within the North Fen, possibly depriving the calcareous fen of part of its premining water supply. Monitoring was designed to investigate these conditions.

Monitoring began at this gravel mine because DNR ecologists had noted that the North Fen was no longer as high quality of a calcareous fen as the South Fen. The major change on the landscape was upgradient gravel mining; thus, concern was expressed that mining had negatively affected the North Fen.

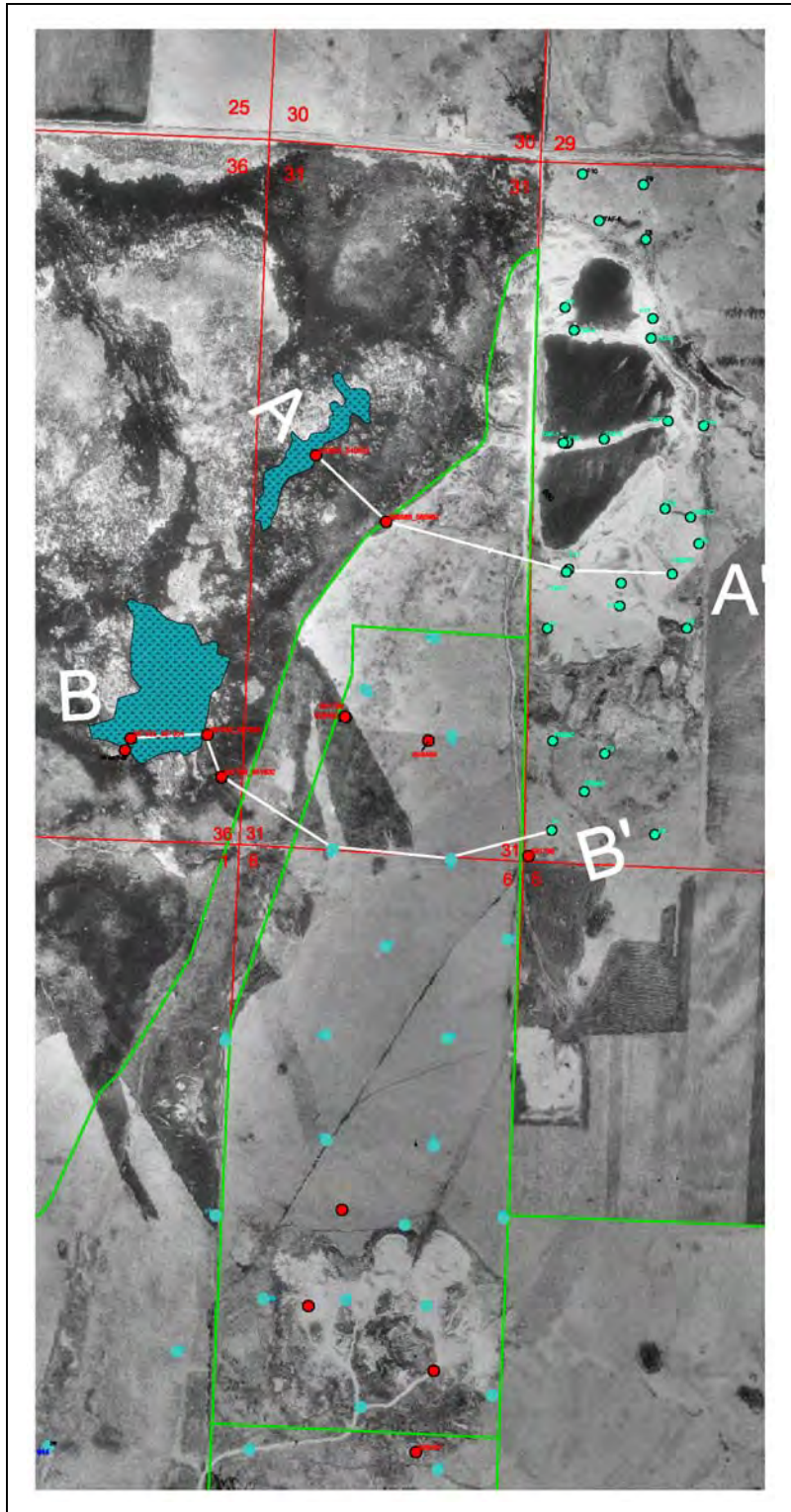

Figure 10.2. Locations of cross sections in the Felton pit area.

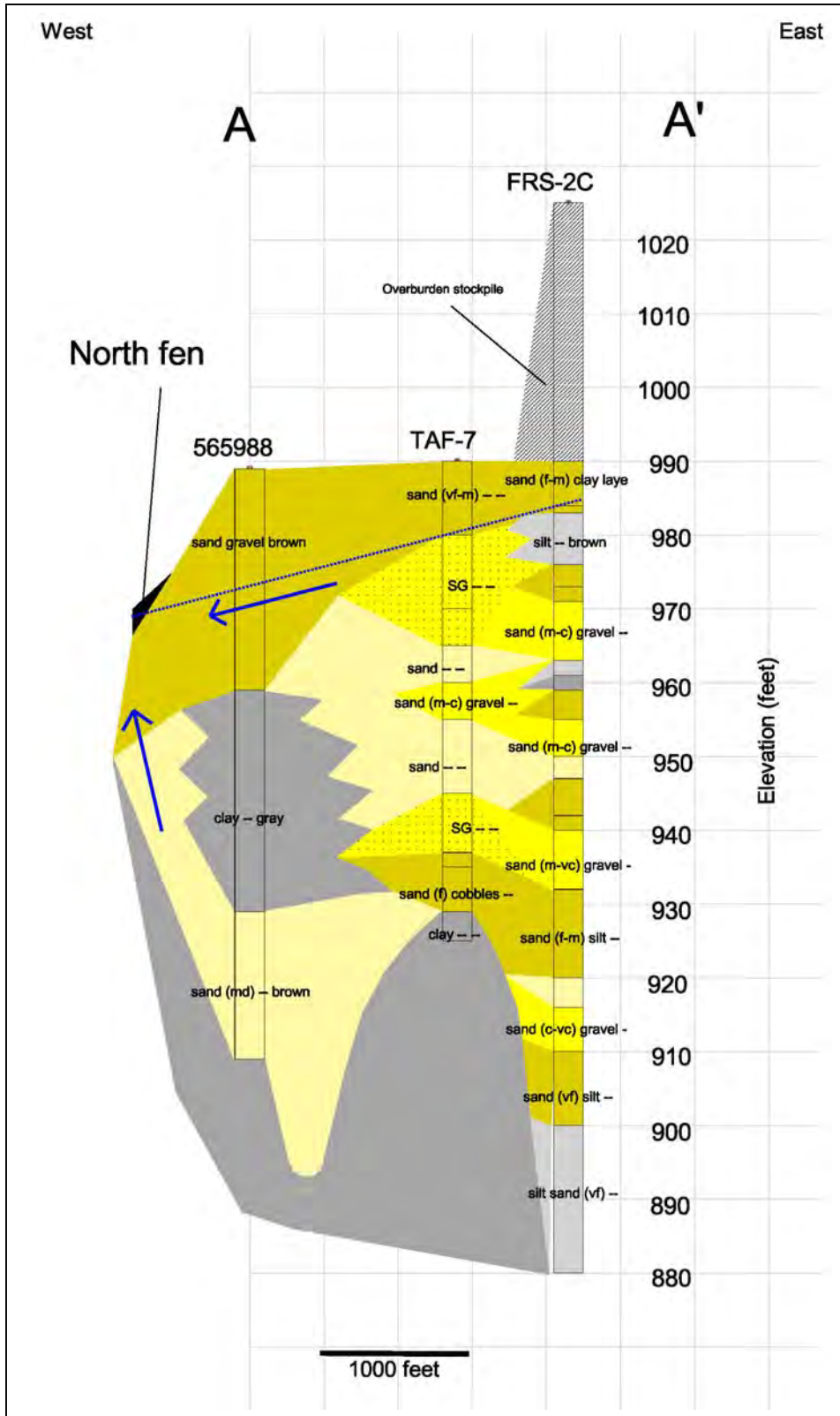

Figure 10.3. Geologic cross section along a trace between the North Fen and the Trust Fund Gravel Pit.

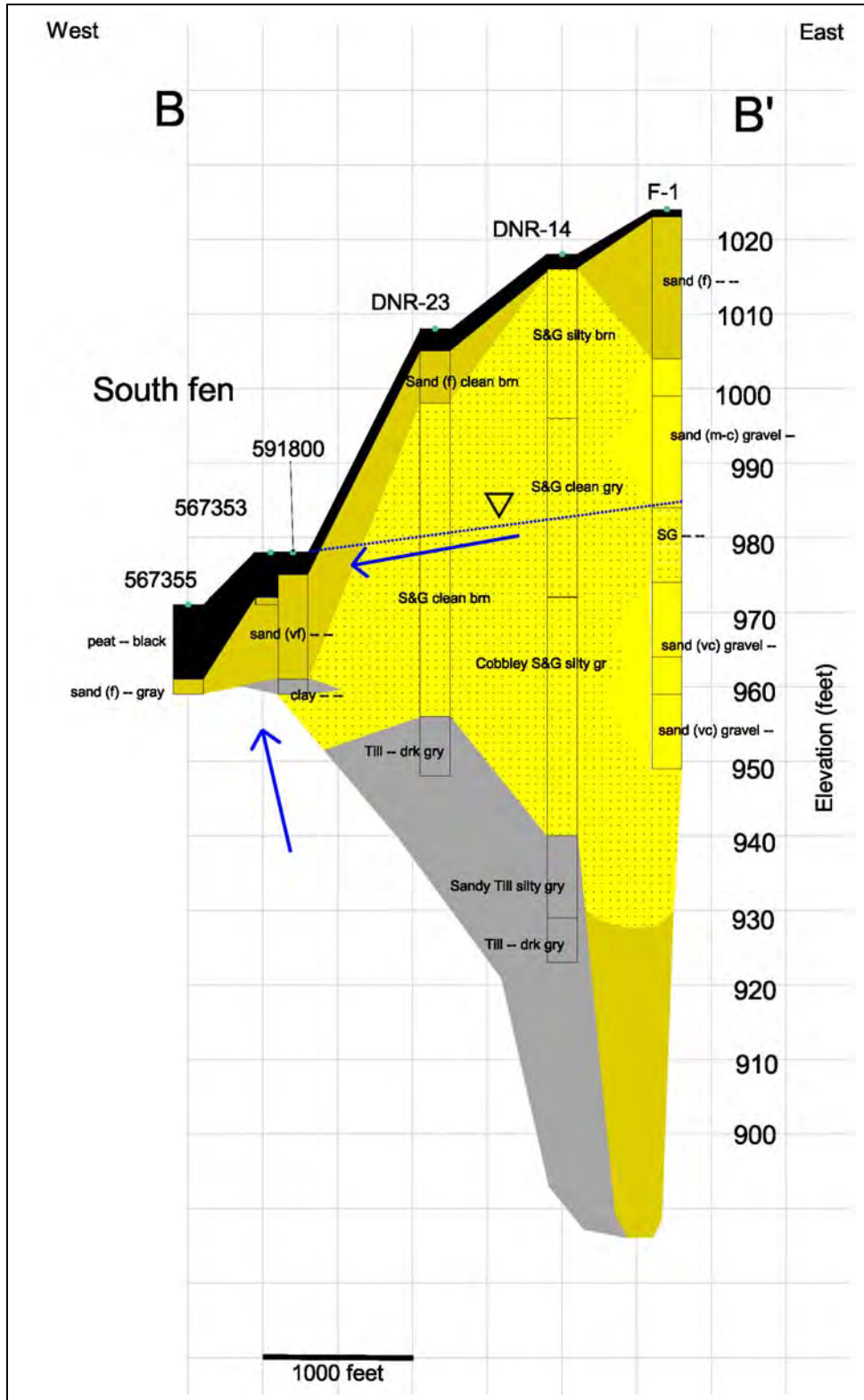

Figure 10.4. Geologic cross section along a trace from the South Fen to the height of the beach ridge south of the Trust Fund Pit.

Impacts on Ground-Water Flow Paths

Mining in the pit has altered ground-water flow paths. The premining flow paths (Figure 10.5) were parallel, northwest-trending lines perpendicular to the beach ridge; simply put, ground water was flowing downhill. This flow pattern resulted in the creation of a seepage face at midslope where the water emerged at ground surface, keeping wet at all times the entire calcareous fen wetland.

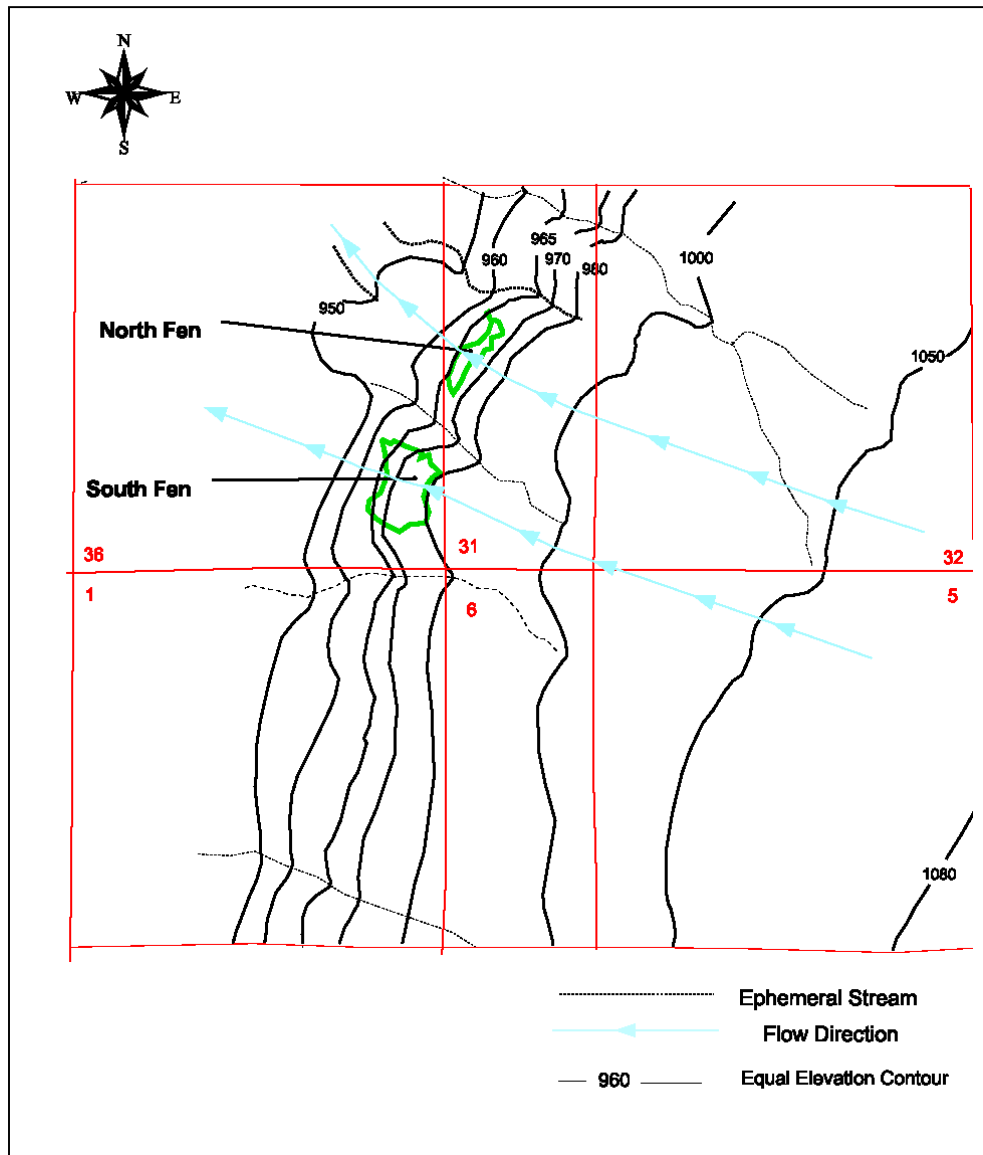

Figure 10.5. Ground-water flow paths (blue) prior to mining.

Figure 10.6 shows the current condition of the South Fen. Mining created a radial flow pattern toward the pit along its south and west borders, resulting in a diversion of some water that would have flowed toward the North Fen and resulting in a decline in the amount of ground water available to the North Fen.

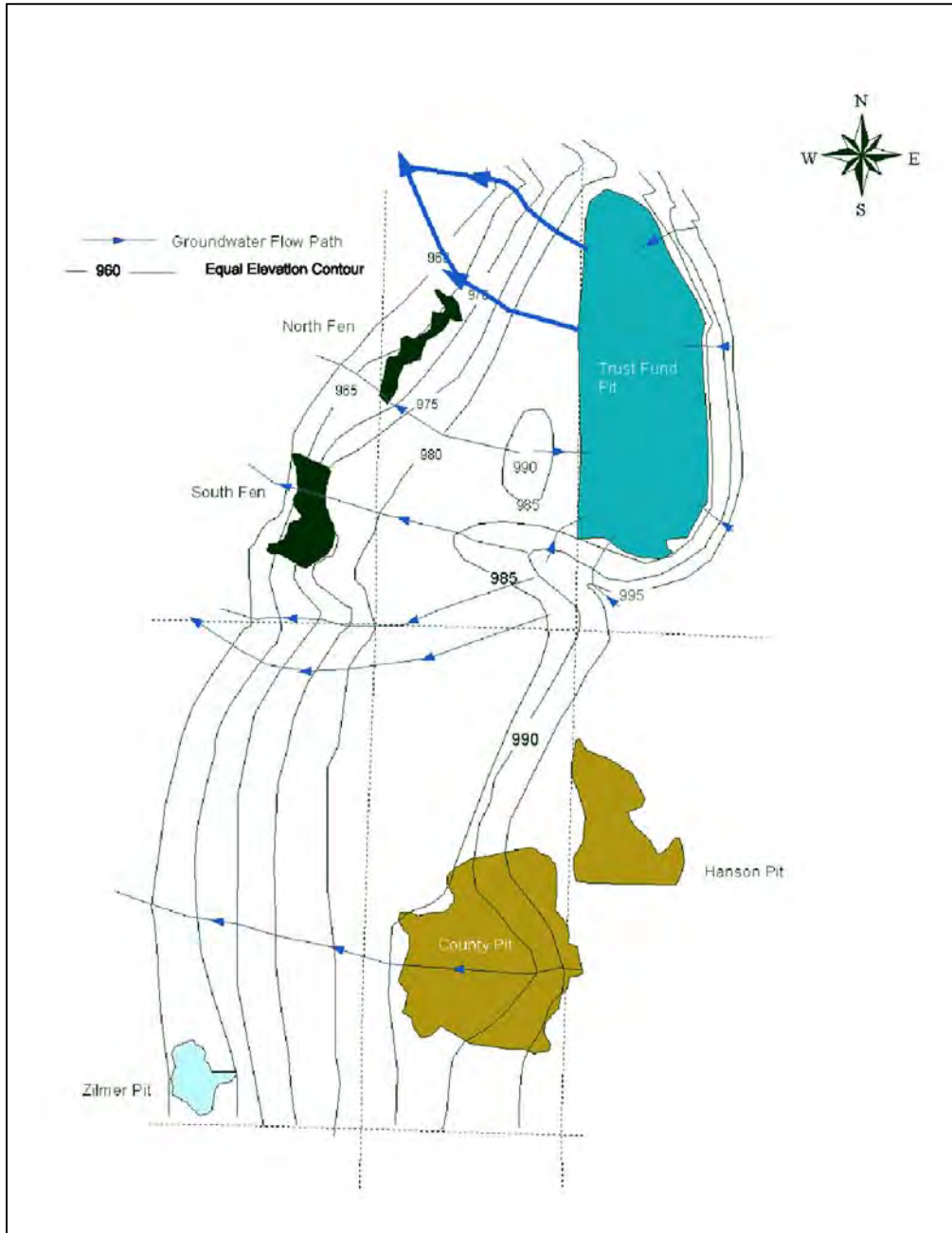

Figure 10.6. Ground-water flow paths (blue) during mining.

Impacts on Water Table Elevations

The decline in the water table elevation since the start of excavation below the water table is estimated to be approximately 15 feet. Note that this change has occurred without direct pumping from the pit for dewatering. The combination of the changes in flow paths and the decline in the water table has eliminated a portion of the ground-water basin of the North Fen. The ground-water basin of the South Fen has been affected to a lesser degree. The expression of this impact is seen in the hydrographs that show vertical ground-water gradients. An upward ground-water gradient underneath the calcareous fens provides the ground-water supply to the surface. Where

there is an upward gradient, the water level in a deep well will rise higher than the water level in a shallower well. The greater the difference in these water levels, the greater is the pressure that moves the ground water upward.

At the North Fen (Figure 10.7), the water level in the deeper well (1D) rises higher than the water level in the shallower well (1S); thus, there is an upward gradient. The difference between the two water levels is about 0.5 ft.

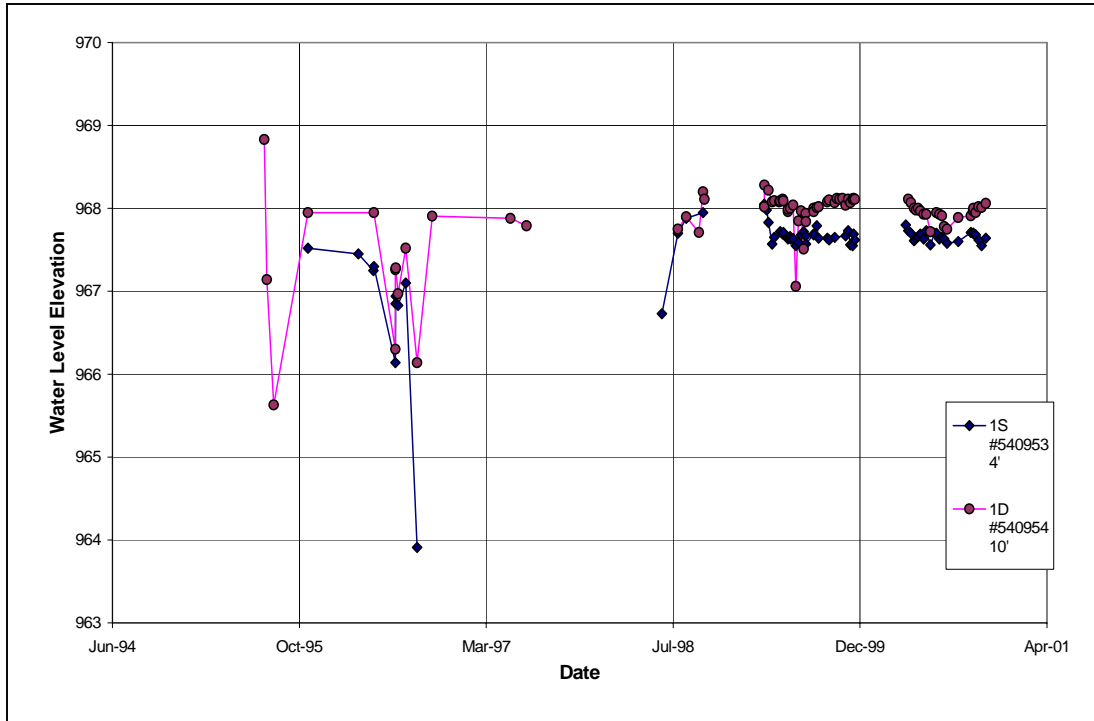

Figure 10.7. Vertical gradient at North Fen.

At the South Fen (Figure 10.8), the water level in the deeper well (2D) rises about 1.5 ft higher than the water level in the shallower well (2S). The potential for ground-water upwelling is about three times greater at the upper edge of the South Fen (where these wells are located) than within the North Fen.

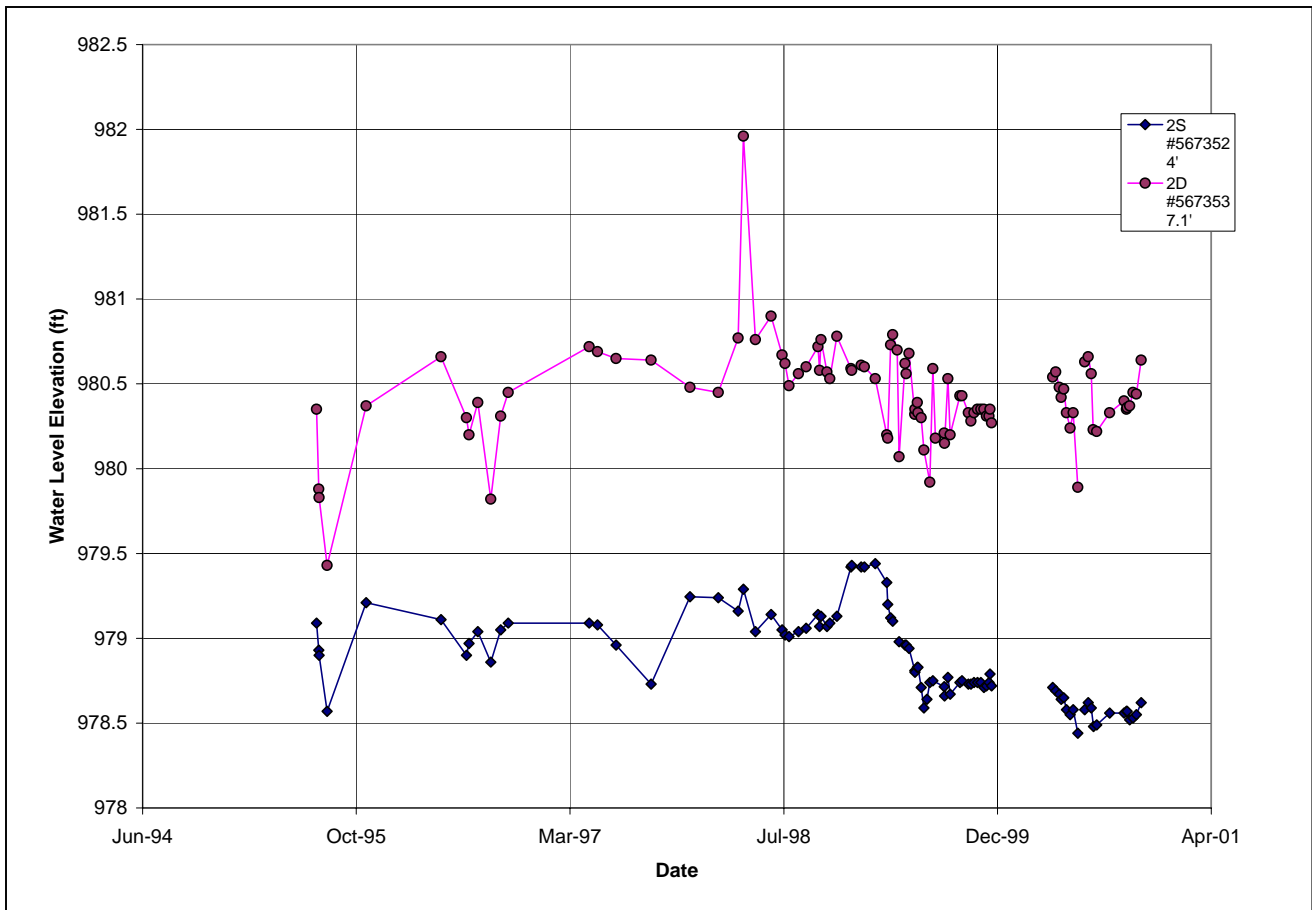

Figure 10.8. Vertical gradient at South Fen.

Impacts on Surface-Water Flow and Water Quality

Changes in the surface-water basin direct runoff into the mine pits and from there into a ditch system. Increased flows into the ditch system have caused headward erosion and caused beavers to be attracted to the area. Beaver dam construction and blowouts have caused fluctuations in the water table and have also caused overland flows and sediment deposition into the wetland complex downgradient of the mine. The materials between the mine and the ditch are not known to be stable; thus, the possibility exists that the whole gravel mine lake could drain catastrophically.

Conclusions

Ground-water flow paths, water table elevations, ground-water gradients and both surface- and ground-water basins have been altered by mining below the water table. Excavation of the pit has caused water levels to decline near the mine and downgradient of the mine. The effect, as much as a 15-foot water level decline, is due to redirection of ground-water flow to the pond and then to the ditch system and is due to evaporation from the pond surface.

The mine is located above a steep slope where watershed changes have set up the potential for subsurface piping and dike failure, which could lead to the loss of the gravel pit lake, complete drainage of the North Fen, and significant impacts on the South Fen.

Mining in the vicinity of calcareous fen wetlands must be undertaken only after evaluation of potential impacts on calcareous fens and planning to avoid those impacts.

Hydraulic Impacts of Quarries and Gravel Pits

II. Outcomes Sections

1. Conclusions
2. Recommendations to Local Government Units for Quarries and Pits



SECTION 1. CONCLUSIONS

Based on our project monitoring and investigations, we have reached the following conclusions about the hydrologic impacts of quarries and pits:

Impacts of Quarries

Ground-Water Levels

When limestone quarries are dewatered to allow mining below the water table, they alter ground-water levels and flow direction. In essence, the quarries become huge wells. Ground-water levels were found to have dropped up to 70 ft; this lowering of the ground-water levels can affect wells on neighboring properties and surface-water bodies. New quarries that will extract material below the water table will have to be sited carefully to avoid this impact, or a plan must be developed to provide an alternative water supply for property owners whose wells are affected.

Ground-Water Flow Paths

Limestone quarries can alter ground-water flow paths by the removal of the aquifer material and the subsequent breaching of the limestone conduits without active dewatering of the quarry. At one site investigated, 90% of the ground-water basin's flow is now surfacing in the quarry. Ground water that previously discharged at a spring now discharges in the quarry where it is exposed to quarrying activities. This premature surfacing of the ground water also alters its temperature, changing the temperature characteristics of the receiving stream and potentially affecting its aquatic life. Our investigations found this scenario most likely to occur when quarries are located upgradient from and close to springs.

Modeling has shown that quarry dewatering at one site is drawing water from a nearby river. Additional impacts could not be assessed because of the lack of hydrologic data from areas surrounding the quarry. It is likely that the dewatering has decreased the yield of nearby wells at this site.

Quarry Blasting

Monitoring and visual inspections of the observation wells at two of the limestone quarry sites found no impact from quarry blasting on ground water turbidity or well integrity. Turbidity monitoring at a spring downgradient of one limestone quarry did find an increase in turbidity that could be attributed to quarry blasting; however, precipitation events had a greater impact on turbidity levels. Based on these findings, the domestic wells most likely to be affected by quarry blasting are older wells (completed before enactment of the state well code) finished in the surface limestone formation.

Impacts of Pits

Ground-Water Levels

Our monitoring found no negative impacts on ground-water levels from sand and gravel pits in alluvial deposits that operate below the water table but do not dewater. These pits will not affect the quantity of water available to shallow domestic wells on neighboring properties.

In the complex geology of glacial beach ridge settings, the removal of sand and gravel can alter ground-water flow paths and affect the supply of water available to wetlands that are fed by discharge from the sand and gravel.

Ground-Water Temperature

Open-water ponds created by sand and gravel mining change ground-water temperatures. The magnitude and extent of those changes is not yet known. This is an ongoing concern that needs further study.

SECTION 2. RECOMMENDATIONS TO LOCAL GOVERNMENT UNITS FOR QUARRIES AND PITS

The following list of questions and materials is designed to help local government staff and officials focus on water resource issues when evaluating aggregate mining proposals. Other issues that need to be considered such as noise, dust, and road impacts are not included in this document. Much of the information required to answer the questions is obtained by mining companies prior to applying for a permit as they conduct their own site evaluations.

Topography

These questions will allow you to assess the mining company's ability to identify any potential impacts of flooding or runoff in the affected area.

- What is the slope of the area?
- If the land is sloping, where will runoff go?
- Is the site in a floodplain?

To answer these questions, a topographic map of the site should be provided. The map should include the following features:

- Elevations
- Roads
- Surface-water bodies
- Property lines
- Buildings
- Equipment and fuel storage areas

If part of the property is in a floodplain, an accurate floodplain delineation based on site survey and hydrologic data should be included in order to assess the risk of inundation of the mine, equipment, and fuel storage areas.

Geology

These questions will allow you to assess the operation's size, future expansion possibilities, depth of mining, and the potential for overburden stockpiling.

- What is the size of the deposit?
- How deep is it?
- How much overburden is there?
- Are there geologic boundaries (change from one type of material to another)?
- Are there clay or shale units present that might act as aquitards?

To answer these questions, a geologic map, at the appropriate scale should be supplied. It should display the following:

- Areal extent and depth of the deposit
- Geologic units and contacts
- Confining units (clay, shale, siltstone)

- Depth to bedrock (if applicable)
- Cross-sections diagrams of the deposit and site
- Fracture patterns and traces (rock quarries)
- Test hole locations

Hydrology

These questions will allow you to assess the impact the proposed operation might have on wells and surface-water bodies.

- What is the water table elevation in the deposit?
- Which way is the water flowing through the deposit?
- What aquifers are present?
- Will the mine be wet or dry? That is, will it be dewatered?
- Are there wells on the neighboring properties?
- How deep are they?
- Do they get their water from this deposit?
- What is the likelihood for impact on these wells? It will be greater if they are in the same aquifer that the deposit is.
- Are there surface-water bodies nearby that might be at risk?

To answer these questions, a map should be supplied that displays the following:

- Water-table elevations with ground-water flow direction
- Wells with depth, static water level, age, and construction
- Surface-water bodies and their elevation
- Springs
- Karst features (if applicable)
- If the pit or quarry is to be dewatered, the plan for that should include the following:
 - dewatering points and their elevations
 - proposed volume and rate of dewatering
 - discharge point
 - duration of dewatering

Karst Investigations

Due to the nature of karst conduit ground-water flow, limestone quarries have the potential to affect water resources that are not immediately adjacent to the site. In order to evaluate this potential, some additional information is necessary; a licensed professional geologist with experience in karst mapping and hydrology should obtain this information:

- A survey in the area of known caves, joints, or fractures
- Mapping of sinkholes, stream sinks, and springs
- Trout stream locations

Dye tracing to determine the ground-water flow paths and the potential connection of the site to springs in the area may be necessary. This information will help to ensure that the quarry is sited in an area with the least likelihood of affecting local springs through dewatering, contaminant introduction, or thermal degradation.

Monitoring

Monitoring Wells

After all of the site investigations are completed, if significant impacts on local water resources or wells are probable, a monitoring plan should be developed. If monitoring wells are necessary for that plan, these are recommended requirements for monitoring wells:

- Such wells should be located around the perimeter of the mining area, and sited after consideration of the possible impacts and the current configuration of the water table, piezometric surface, or both.
- Where multiple aquifers are involved, such as removal or dewatering of a surficial aquifer during excavation of a lower unit, both the upper and lower units should be monitored by installing a deep well and a shallow well in a “well nest”. To establish ground-water flow directions, a minimum of three wells are needed.

Additional Precautions

These additional precautions are necessary if a formation is used both for sand and gravel operations and for water supply.

- Ground-water modeling may be needed to determine how much material can be mined without severely impairing aquifer function by changing the ability of the formation to transmit water.
- Mining should not be allowed to the edge of the formation (where it meets upland deposits).
- Since these operations typically result in an open-water area, those areas need to be protected. No fine-grained materials should be deposited in them and the areas should not be used for any type of waste disposal.

Mining Plan

Compiling the information on topography, geology, hydrology, karst (if applicable), and monitoring will allow for the development of a mining plan. The following questions will allow you to assess the overall scope of the mining operation, its impact on neighboring properties, and its plan of operation.

- How large of an area will be mined?
- How deep will the mine be?
- How will mining operations be staged?
- How will the overburden spoils be stored?
- What mitigation measure will protect against flooding?
- What mitigation measure will prevent or manage runoff onto surrounding properties and surface-water bodies?

To answer these questions, a detailed mining plan needs to be supplied that displays the following:

- Mining progression
- Final depth of the mine
- Spoil pile locations and treatments
- Material processing plans including washing sites, water sources, and treatment methods
- Equipment maintenance areas
- Road locations

Reclamation Plan

These questions will allow you to evaluate the adequacy of ongoing reclamation activities during mining and the condition of the property after mining ceases.

- What reclamation activities will occur during active mining?
- What will the slopes of the area be?
- Will there be an open-water body? If so, what will be its shape, depth, and slope?
- What type of vegetation will be planted?
- What will be the land use after mining ceases?

To answer these questions, a detailed reclamation plan should be supplied that displays the following:

- Stages of reclamation
- Reclamation methods
- Source of reclamation material
- Grading and slope of the reclaimed areas
- Vegetation planning including map of plantings and description of seed mixtures and seed sources
- Shape and slope of any open-water areas
- Future use of the site

Hydraulic Impacts of Quarries and Gravel Pits

III. Appendices

1. Sampling and Data Collection Methods
2. Three-Dimensional Characterization of the Spinler Quarry
3. Glossary
4. List of References



APPENDIX 1. SAMPLING AND DATA COLLECTION METHODS

Water Level Measurements

Water level measurements proved the most basic and most crucial information for ground-water studies. Thus, the methods for performed water level measurements must be standardized for both automated and manual water level measurements.

For both automated and manual water level measurements it must be clear from what point on the well measurements are supposed to be taken, as this measuring point (MP) is the key link to determining water level elevations from depth to water measurements. In most cases, the MP will be the top of the free-standing casing. However, there may be circumstances where the MP will be an access plug located elsewhere. Irrigation or other high-capacity wells often have a plug near the base of the turbine or have an access tube angling off from the turbine base. All of the wells used in the project were monitoring wells without any obstructions, so the highest part of the inner casing was the measuring point.

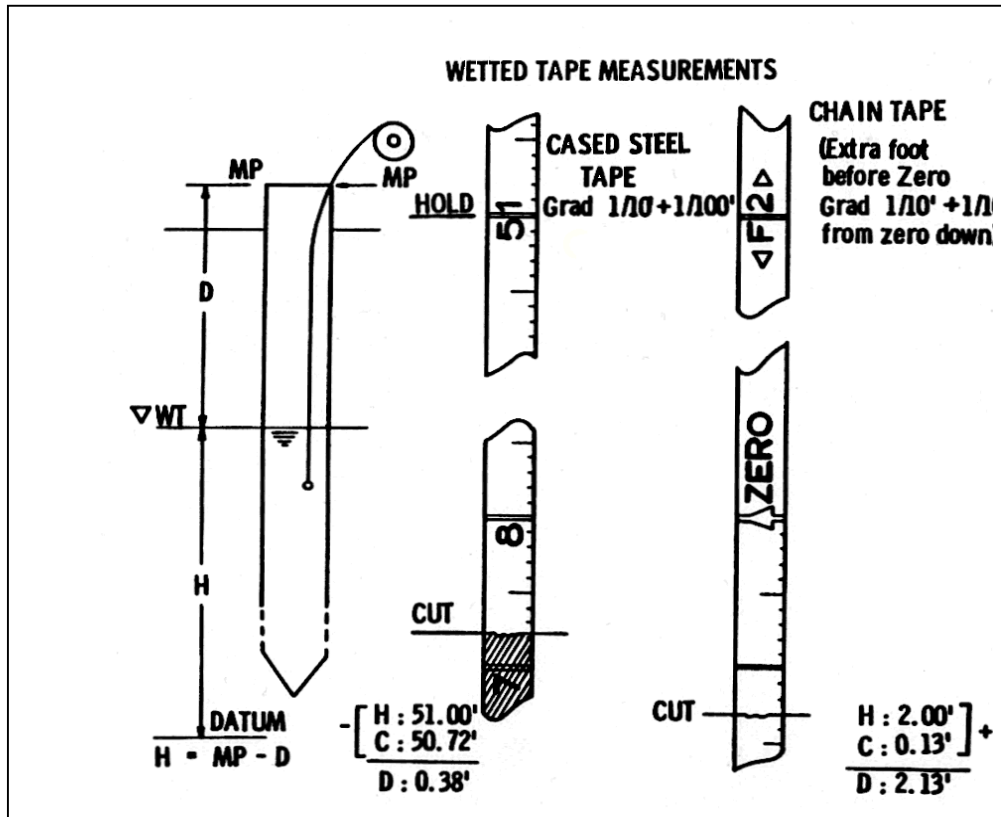

Figure 1. Steel tape.

Steel Tape Measurements

Before use, the steel tape (Figure 1) needs to be wiped dry and then coated with carpenter's chalk. To do this, a portion of tape (5 ft is usually sufficient) is unreeled and, while a person holds the reel in one hand, the chalk is pressed against the numbered side of the tape and pulled along toward the free end until the unreeled tape is coated with the light blue chalk.

An estimate of depth to water or information from past readings is used to determine where to hold the tape in order that the wetted length falls within the chalked portion of the tape. The chalked tape is lowered into the well until some of the chalked portion is in water and then it is lowered slowly until a whole-foot mark on the tape is exactly at the measuring point. This measurement is recorded on the data sheet as “tape held” or “hold”. The tape is not allowed to fall past this chosen hold; to do so would result in an erroneous reading.

The tape is reeled up and the measurement is carefully read to the closest hundredth of a foot, (0.00’) at the point where the chalk becomes wet and turns to a dark blue color. This is the “wetted length” or “cut” measurement and is recorded on the data sheet. The wetted length is subtracted from the tape held and recorded on the data sheet as “depth to water” or “DTW”. The reading is compared to previous readings, and if there is a significant difference, a second reading can be taken.

Wells were measured primarily with an Envirotech Waterline model 300 engineering scale water level meter (Figure 2). As a backup, a steel tape was used when the Waterline was not available or conditions prohibited its use. The Waterline we purchased was 150 ft long and used a scale that was marked every tenth and hundredth of a foot.

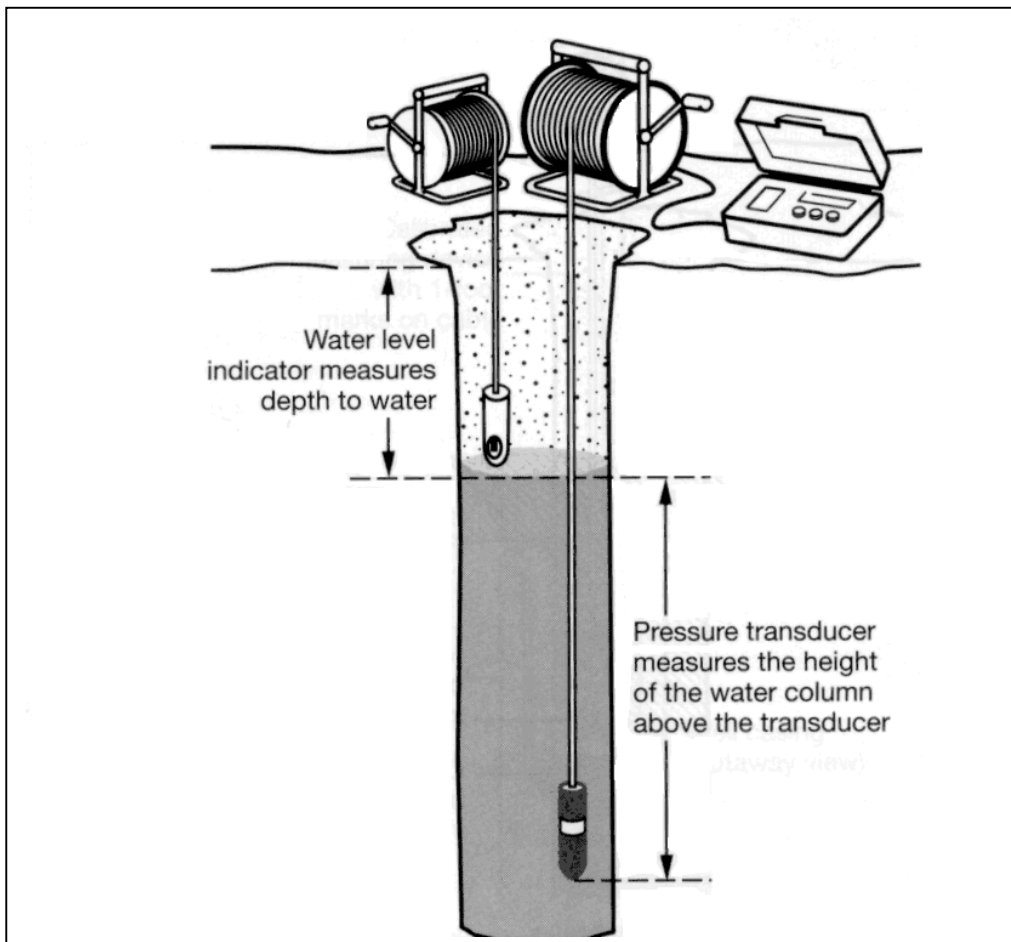

Figure 2. Electronic water level meter.

The wells were all surveyed and referenced to either a local or nationwide benchmark (mean sea level). In most cases, this was the highest point on the casing and became the measuring point for all future readings. The depth to water in the wells was measured by lowering the probe end of the Waterline down the well until an audible signal was heard. The point when the tone was heard is the depth to water; it is measured, to the nearest hundredth of a foot, from the probe end to the measuring point using the graduated scale on the instrument.



Figure 3. Water level measuring at a wellhead.

Several of the study wells were instrumented with pressure transducers from INW, Keller, and Solinst that continuously measured water levels in the wells. Pressure transducers measure the pressure of the water column above a pressure sensitive membrane of the transducer. Each transducer came factory calibrated with a slope and offset, which allow the user to calculate the height of the water column from the pressure measured by the transducer. The transducer-specific slope and offset were entered in a datalogger, typically a CR10 or CR10X, along with programming instructions that enabled the datalogger to run the pressure transducer and make all of the necessary calculations.

The transducers were programmed to measure water levels every 15 minutes and this was recorded by the datalogger. When the datalogger was downloaded, the current water level reading measured by the transducer was compared to the water level measured by the Waterline or steel tape. If a significant difference was noted, the offset in the transducer's program was adjusted so that the water level shown by the pressure transducer was the same as that measured by hand. The data usually needed additional corrections to account for transducer drift from aging of the membrane.

Elevation Survey Methods

Water level measurements must be tied to a common datum as was discussed above. Several of the partner companies provided accurate survey data for wells installed on their property; in other cases, level surveys were conducted from federal and state benchmarks in the vicinity of the quarry or pit using survey-grade global positioning system (GPS) equipment.



Figure 4. Climate monitoring equipment.

Climate Monitoring Methods

Climate monitoring was accomplished primarily with weather stations (Figure 4 above) located at the Felton, Kraemer, Golberg, Spinler, and Fountain sites. The weather stations monitored precipitation, wind speed, wind direction, solar radiation, barometric pressure, and relative

humidity. Of these, precipitation and barometric pressure were the most important information collected from the stations.

The weather stations were built around Campbell Scientific CR10, CR10X, or CR21X and programmed with PC208W. This configuration allowed us to customize how the data were collected and the frequency of collection. For most applications, the sensors would take readings continuously, store the data hourly, and summarize the data daily. Barometric pressure was collected at 15-minute intervals, which was the same as the pressure transducers since several of the transducers required a barometric pressure compensation to provide adequate data resolution. Precipitation measurements were collected every minute during rain events. Snowfall was not well represented because the precipitation gauge was not heated and much of the snow would sublime or blow off the gauge before it could melt and be recorded. Precipitation was compared to hydrographs to determine whether there was any correlation between ground water levels and precipitation.

During periods of datalogger failure, precipitation was filled in from the Minnesota Climatology program High Density Network. These data were used sporadically because rainfall can be highly spatially variable; what is measured at a station a mile away can be greatly different than what is measured onsite.

Dye Tracing in Limestone

Purpose

Using artificial additives (tracers) to track ground-water flow is a widely used tool in karst aquifer investigation. A tracer is added to the ground-water system at a sinkhole, sinking stream, or cave stream and then it is sampled for at those points, springs, where the ground-water system discharges to the surface. When done successfully, this point-to-point tracing technique provides a significant amount of information about the ground-water flow system. When point-to-point connections are known, they can be used to delineate the area that contributes water to a spring (springshed). If water samples are taken regularly during the tracing experiment, the ground-water time-of-travel, its rate of movement, can be determined. This information can then be used to evaluate the impacts of quarries and other land uses.

For this type of work, the tracer should be conservative (i.e., travel at approximately the same velocity as the water molecules). For that reason and because they are readily obtainable, nontoxic, and relatively simple to analyze, the preferred karst tracers are fluorescent dyes. Many fluorescent dyes are available to use; however, through extensive field experiments only a few have proven suitable for ground-water tracing. This suitability is based on the tracer being recoverable from the water, having a low tendency to adsorb on to the aquifer material or suspended sediment in the water, and low toxicity to plants and animals.

Protocol

For this study, the dyes used were eosine (CAS 17372-87-1), Rhodamine WT (CAS 37299-86-8), and uranine C (CAS 518-47-8). Three dyes were used to allow us to trace up to three different sinkholes at the same time.

For traces outside of the quarry, 0.9 to 1.8 pounds of dye were flushed with approximately 9,000 liters of water from a tanker truck. The traces that were conducted in the quarry used water that was emanating from springs in it. The dye was poured into those streams of water which then

sank underground (Figure 5). Prior to dye input, samples of the spring water at Big Spring and other area springs were obtained to determine background levels of fluorescence in the ground-water system.



Figure 5. Introducing dye into the stream of water.

Sampling

Passive charcoal detectors and direct water samples were used for sampling. Charcoal detectors were constructed by placing 0.01 ounce of activated carbon coconut shell in a 5 cm by 20 cm section of milk sock filter tube stapled on both ends. A tag was attached to the detector with a short wire. This wire also served to attach the detector to a weight, which prevents the detector from washing away (Figure 6). The tag was used to record the name and number of the spring being sampled and the time and date the detector was both put into the spring and when it was retrieved.



Figure 6. Sampling materials.

Analysis

Dyes were recovered in the laboratory by placing about 1 gram (dry weight) of activated carbon into a disposable test tube; a mixture of water, sodium hydroxide, and propanol was added to the carbon. This mixture would “pull” the dye off the carbon and put it into solution so it could be analyzed. The remaining carbon was stored in a freezer for later re-analysis if required. For the direct water sample analysis, only a small portion of the sample taken in the field was used; the rest was saved for re-analysis if needed.

Fluorescent dyes absorb light and reemit it at longer wavelengths. The ideal wavelength at which the dye re-emits that energy is called the peak emission wavelength, where most fluorescence occurs. Fluorometers are used to detect fluorescence below visual levels. The fluorometer supplies light at the peak excitation wavelength and then measures the intensity of the light at the peak emission wavelength (Fay and Alexander, 1994). All of the samples were analyzed with a Shimadzu RF5000 scanning spectrofluoro-photometer at the University of Minnesota Department of Geology and Geophysics. This instrument uses a synchronous scan mode that varies the peak emission and excitation wavelengths. The resultant dye peaks were analyzed with PeakFit nonlinear curve-fitting software. Using this method made it possible to analyze for all three dyes at the same time and distinguish them from naturally occurring fluorescent materials.

Dye Tracing in Sand and Gravel

Protocol

Dye tracing can be used to determine ground-water travel time and flow direction in sand and gravel (porous media) aquifers. A tracer is introduced into the aquifer and then samples are taken at excavations and wells. The tracer used should not adsorb easily on to the aquifer material. Uranine C and eosine have lower adsorption tendencies than Rhodamine WT; thus, they are the dyes of choice for porous media aquifer studies.

Analysis

The samples were analyzed using a Turner Designs Aquafluor fluorometer. The Aquafluor is a handheld unit that was configured to analyze for uranine C and Rhodamine WT. All of the analyses for the sand and gravel dye trace were carried out with this unit. These analyses had no costs since we did not have to send the samples to the University of Minnesota Department of Geology and Geophysics. It also allowed for virtually instantaneous results as we could take a sample at the pit, return to the office, and analyze it immediately. This allowed us to track the dye increase in trench 2 and indicated when we needed to stop sampling due to dye concentrations that were exceeding the upper limits of the unit's measurement range.

Water from the sample bottles was pipeted into a disposable cuvette that was placed in the Aquafluor. The resulting readings were recorded and plotted to determine when the dye broke through to the sampling excavation. Overall, the unit performed well and allowed for quick and accurate analysis of the samples.

Turbidity

Turbidity is a measure of the cloudiness or ability of light to pass through water in straight lines. Water with a high turbidity scatters light in all directions or absorbs light while water with low turbidity allows light to pass through relatively unimpeded. Turbidity is measured in nephelometric turbidity units (NTU). High levels of turbidity are caused by suspended clays, silts, and other inorganic and organic precipitates.

Generally, increased turbidity in a domestic water well is only an aesthetic problem given its visually unappealing appearance for drinking; however, if the turbidity is high enough and occurs frequently enough, it could fill up pressure tanks and clog filtration systems resulting in frequent filter replacement. Currently, the Minnesota Department of Health has not established a maximum contaminant level (MCL) for turbidity. The American Water Works Association (AWWA) and the U.S. Environmental Protection Agency require that turbidity be maintained below 1.0 NTU for all public water supplies.

Through the process of rock crushing and processing in rock quarries, large quantities of fine materials are produced and can be washed into the ground-water system by rain events. In addition, ground vibrations produced by blasting can dislodge small particles in fractures and conduits, which can increase turbidity.

Over the years, we have received anecdotal reports of mining activities and blasting affecting nearby domestic wells through increased turbidity; however, we could not verify any of these reports. Given the proximity of our monitoring wells to the active quarries being studied, we

decided to install turbidity sensors in the wells to measure turbidity changes in the ground water and document the impacts that have been described to us. We hypothesized that blasting would send enough energy through the rocks to dislodge fine particles and cause an increase in turbidity in the monitoring wells.

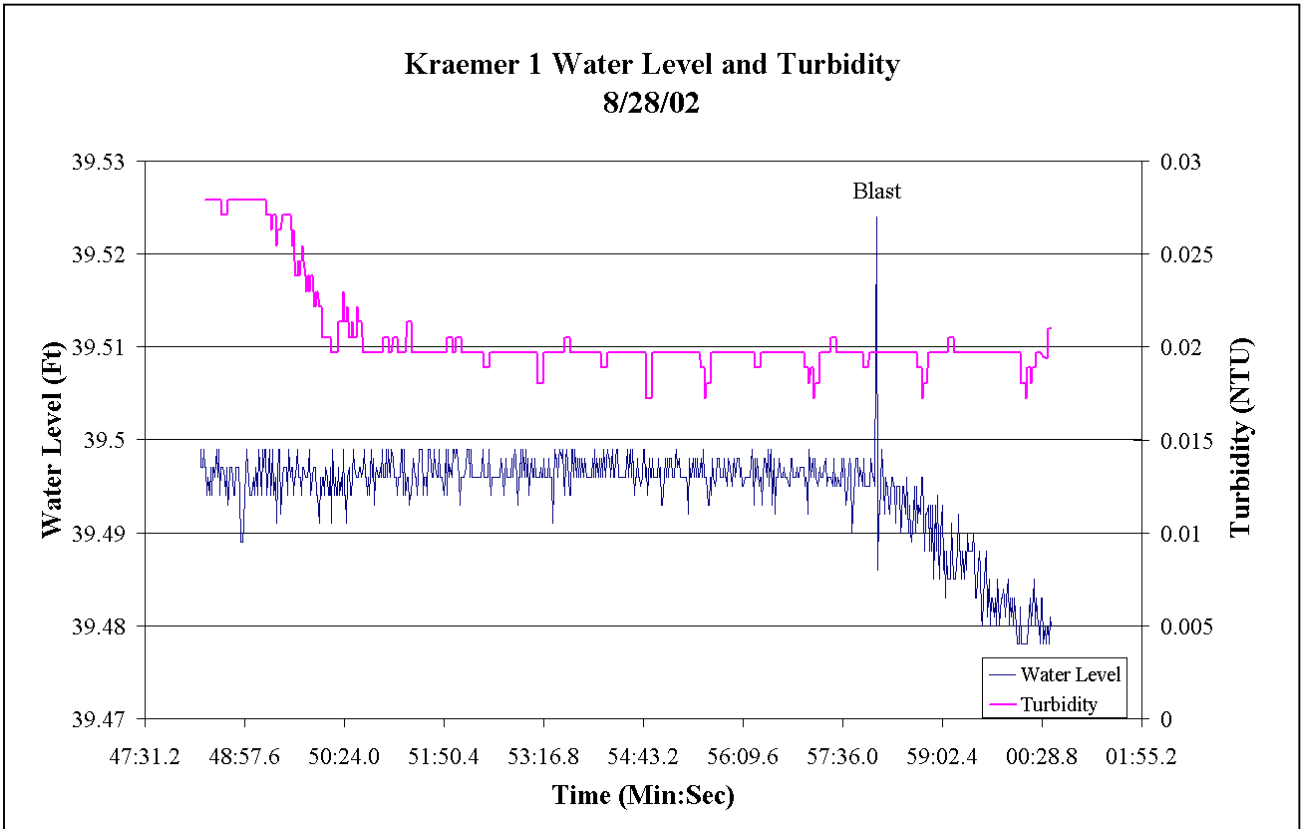

Figure 7. Water level and turbidity before and after a blast at Kraemer quarry.

Turbidity sensors work by emitting a pulse of light between an emitter and a sensor and then measuring the amount of light that is scattered to a second sensor perpendicular to the original path of the light. The turbidity is inversely proportional to the amount of light reaching the first sensor and directly proportional to the amount of light that reaches the perpendicular sensor.

The first pieces of equipment we tried were Global Water WQ series sensors in project wells at Kraemer and Golberg quarries. While the equipment was promising, consistent readings could not be obtained with either the hand-held turbidimeter or the sensors. The signal noise was much greater than any real changes in turbidity. In many cases, the readings would change by an order of magnitude within a second or two. Figure 7 is a graph of data collected by the Global Water sensor during a blasting event at Kraemer Quarry. Just before and just after the blast, turbidity levels were fairly stable. The second graph (Figure 8) is for a blasting event at Fountain Quarry. The readings were collected every 15 minutes and there is so much noise in the data that no trends can be distinguished. Even a running average was unable to identify any real trends. These data are characteristic of the data that we received from this equipment.

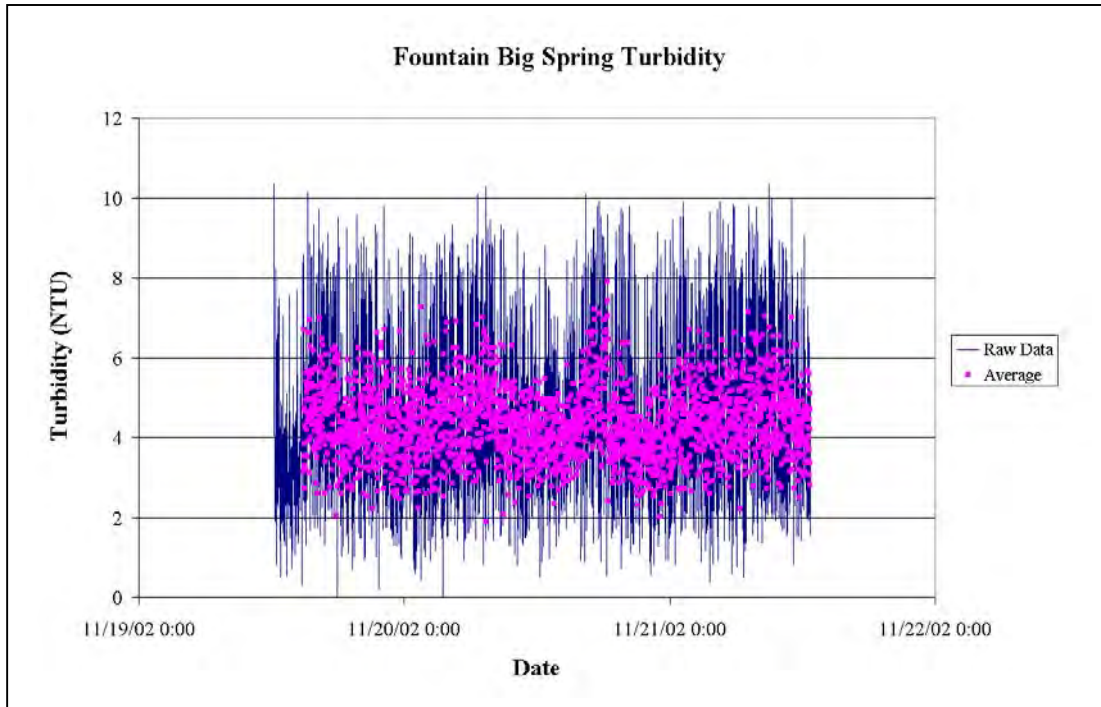

Figure 8. Turbidity readings from a blasting event at Fountain quarry.

The second piece of equipment we tried was a Greenspan TS series turbidity sensor with built-in datalogger from Stevens Hydrologic Systems. The sensor was deployed in a cave spring downgradient of the quarry at Fountain. It performed extremely well and gave stable and reproducible readings with little signal noise. The unit measured turbidity in some of the largest flows seen at the spring during June 2004 and significant events in June and July 2003. During summer 2004, the unit disappeared from the spring and has not been recovered.

If the study were to be continued, we would have to change how we are monitoring turbidity. Instead of focusing on our monitoring wells, we should search for wells adjacent to quarries that have a history of turbidity after a blasting event and measure turbidity in them before and after a blast. Although we have had vandalism problems at the Fountain Big Spring site, monitoring should continue there because we have noted turbidity increases after blasting but not enough data exist to adequately quantify the impacts.

Although there are little supporting data, mining activities likely do have an impact on local ground water through increased turbidity. This effect is seen mostly at monitoring locations downgradient of the quarry and is most obvious shortly after blasting events. In southeastern Minnesota, the turbidity increase from rainwater picking up quarry dust is insignificant compared to the turbidity resulting from rainwater washing sediment into sinkholes in agricultural or forested lands. Ground water generally moves more slowly through sand and gravel when compared to flow through fractures and solution-enlarged joints in carbonate rocks. In sand and gravel, this lower flow rate allows most of the suspended material to settle out before it can be detected in a monitoring well. Storm induced turbidity responses are shown in Figures 9 and 10.

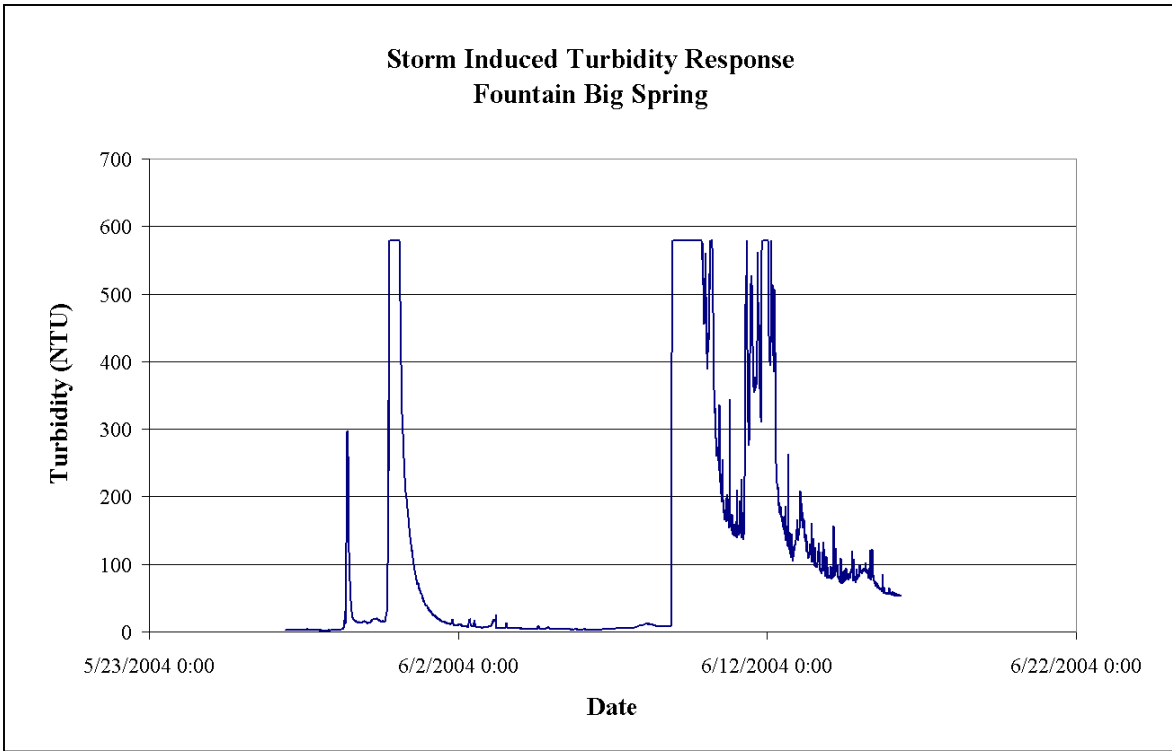

Figure 9. Storm induced turbidity response (2004).

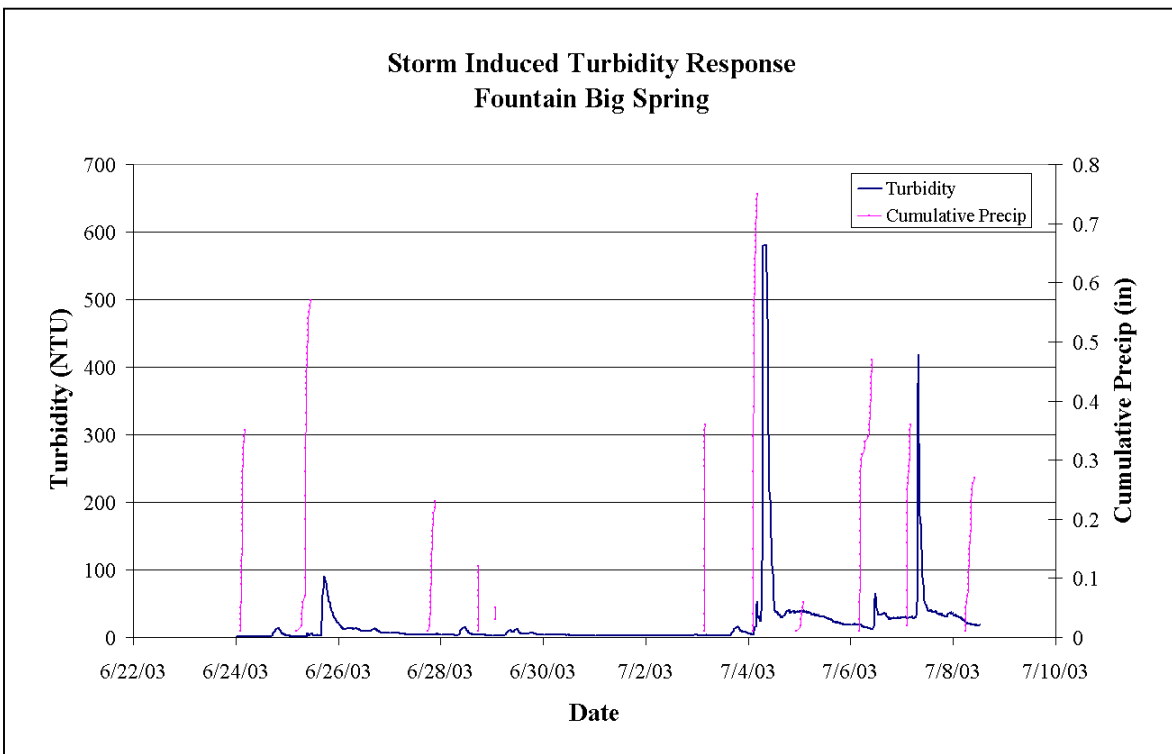

Figure 10. Storm induced turbidity response (2003).

The possibility of a quarry creating ground-water problems needs to be addressed during the planning phase, not after residents start complaining. The potential for turbidity impacts exists in any location where conduit flow is a significant component of the total ground-water flow. The extent of conduit flow can be easily determined by examining local springs after a recharge event. If the springs are cloudy, then conduit flow is significant; but if the springs are clear, then matrix flow is likely predominant. Conflicts between homeowners and quarry operators will only increase as more quarries are opened and as urban sprawl pushes residential homes into the countryside.

Downhole Camera

Downhole cameras have become useful recently not only to inspect the condition of wells but also to examine the aquifer material in open-hole wells. Most cameras are actually two cameras, one looking down and one looking sideways

The camera is lowered into the well on a cable that spools off a truck-mounted winch over a pulley at the end of a boom positioned directly over the well. The “drawworks” are equipped to measure and record the amount of cable being spooled out so that the video can be coded with the exact depth.

Cameras are frequently used with downhole geophysics equipment in which case the geophysical log and visual log can be correlated.

Downhole cameras are used to visually inspect wells and identify and solve well problems. They also can allow identification of zones of high flow in uncased portions of wells. A use for the camera in wells near quarries is to inspect for possible damage following several years of close proximity blasting.

The downhole camera for this project was ordered in October 2004 and received in March 2005. After some initial testing, the camera was deployed for fieldwork in early April.

The camera was purchased in order to allow project staff to visually examine the bedrock monitoring wells at the Kraemer, Golberg, and Spinler quarries. While these wells were instrumented with water level and turbidity recorders, these instruments only gave a partial picture of the conditions in the wells. Using the downhole camera, staff could look for indicators of quarrying impacts. In particular, staff could evaluate the condition of the well casing, examine the open-hole portions of the well for obvious rock movement and high-capacity conduits (visible by the movement of particulate matter in the well), and look for indications of turbidity. Comparison of present and future video logs will allow staff to gain further knowledge on quarrying impacts as the wells age.

Temperature Monitoring

Due to funding limitations, monitoring of thermal impacts of mining operations could not be major goal of this study. Traditional methods are time-consuming and costly. Yet concern about thermal impacts on receiving waters has continued to be a major issue in the southern Minnesota. When a new monitoring technology called thermochrons became available, therefore, it was decided that thermal impacts should be tested.

Thermochrons are digital recording thermometers (Figure 11). These relatively new devices are only about the size of two stacked nickels but include a temperature sensor and recording memory that can keep track of temperature changes for several months. They can be placed in shallow water, for example in streams, springs, or quarry ponds, and later retrieved for data recovery.

Thermochrons cost less than \$50 each and the equipment to communicate with them is also inexpensive and extremely portable, making temperature monitoring in gravel pits and quarries a real possibility.



Figure 11. Thermochron digital recording thermometer compared with a nickel.

APPENDIX 2. THREE-DIMENSIONAL CHARACTERIZATION OF THE SPINLER QUARRY

One of the most difficult tasks a geoscientist faces in describing the geologic setting of an area is to explain in words how it looks under ground. Professional geoscientists need to think in three dimensions. Most laypeople are unable to understand how the earth looks two-dimensionally with topographic maps. Adding the third dimension of space and the fourth dimension of time would have been difficult to portray in the past. Emerging earth science software now allows the geoscientist to construct three-dimensional visual models to aid interpretation of the geologic and hydrologic framework. One of the geoscience's models, Rockworks 2004, was purchased with funds from this study to allow more detailed analysis of the impacts of quarrying on ground-water systems.

Located 6 miles southwest of Owatonna, Minnesota, the Spinler Quarry was analyzed in greater detail than the other project sites; its complex hydrogeologic setting includes the widest range of issues that local and state officials may encounter when considering requests to locate or expand a quarry or pit. Originally operated as a gravel pit, this site has been transformed into a limestone quarry. Encompassing 55 acres, the site's pit comprises 19 acres. Because of confidentiality agreements, the immediate site geology will not be discussed. Tipping and others (2003) described the hydrogeologic environment within which this site resides.

The quarry is currently owned by Milestone Materials of Mathy Construction. At project inception, Crane Creek owned the quarry. Without cooperation and information sharing by Milestone Materials and Crane Creek, this discussion would not have been possible. Their efforts and willingness to allow access to their property and proprietary information are recognized and greatly appreciated.

Hydrogeologic Model

Rockworks 2004 was purchased for the project to aid in the analysis and presentation of the project information in a three-dimensional format. The software allows construction of a digital model using the following input data:

- well logs of the underlying geology;
- well location, elevation, and depth;
- pit configuration and depth; and
- water levels of each aquifer.

Rockworks 2004 is not a hydrodynamic model; it does not compute water levels based on a predictive algorithm. It is a representation of the investigator's hydrogeologic interpretation and observed water levels. It interpolates the information from known data sites to fill in the unknown areas. In spite of the above limitations, Rockworks 2004 is a powerful tool, which presents an unprecedented picture of the subterranean environment.

Figure 1 (below) is a copy of a well log with the model input information highlighted. Well logs are required to be completed for each well constructed by a licensed well driller. The Minnesota Department of Health manages the database called the Minnesota County Well Index (CWI), which contains logs of most of the wells drilled in Minnesota. The Minnesota Geological Survey reviews the well logs to identify the lithology (the physical character of the earth materials through which the well is drilled) of the well and field checks their locations. Well logs are an essential component in any hydrogeologic investigation. Without geologic information garnered

Unique No. 00419588		MINNESOTA DEPARTMENT OF HEALTH WELL AND BORING RECORD <i>Minnesota Statutes Chapter 1031</i>				Update Date 2002/01/28																										
County Name Steele						Entry Date 1991/10/10																										
Township Name Township Range Dir Section Subsection 106 21 W 11 DCDCOC		Well Depth 163 ft.		Depth Completed 163 ft.		Date Well Completed 1987/11/09																										
Well Name HUFFMAN HARRY & BEVERLY		Drilling Method Non-specified Rotary																														
Contact's Name HUFFMAN HARRY & BEVERLY RR 2 OWATONNA MN 55060-		Drilling Fluid		Well Hydrofractured? <input type="checkbox"/> Yes <input type="checkbox"/> No From ft. to ft.																												
<table border="1"> <thead> <tr> <th>GEOLOGICAL MATERIAL</th> <th>COLOR</th> <th>HARDNESS</th> <th>FROM</th> <th>TO</th> </tr> </thead> <tbody> <tr> <td>MED. COARSE GRAVEL</td> <td>YELLOW</td> <td>MEDIUM</td> <td>0</td> <td>72</td> </tr> <tr> <td>CLAY</td> <td>BLUE</td> <td>MEDIUM</td> <td>72</td> <td>78</td> </tr> <tr> <td>LIMESTONE</td> <td>WHITE</td> <td>HARD</td> <td>78</td> <td>100</td> </tr> <tr> <td>LIMESTONE</td> <td>GRAY</td> <td>HARD</td> <td>100</td> <td>163</td> </tr> </tbody> </table>		GEOLOGICAL MATERIAL	COLOR	HARDNESS	FROM	TO	MED. COARSE GRAVEL	YELLOW	MEDIUM	0	72	CLAY	BLUE	MEDIUM	72	78	LIMESTONE	WHITE	HARD	78	100	LIMESTONE	GRAY	HARD	100	163	Use Domestic		Casing Drive Shoe? <input checked="" type="checkbox"/> Yes <input type="checkbox"/> N Hole Diameter in. to 80 ft			
		GEOLOGICAL MATERIAL	COLOR	HARDNESS	FROM	TO																										
		MED. COARSE GRAVEL	YELLOW	MEDIUM	0	72																										
		CLAY	BLUE	MEDIUM	72	78																										
		LIMESTONE	WHITE	HARD	78	100																										
LIMESTONE	GRAY	HARD	100	163																												
Casing Diameter		Weight(lbs/ft)		in. to 163 ft																												
6 in. to 80 ft		19																														
Screen N		Open Hole		From 80 ft. to 163 ft.																												
Make		Type																														
Static Water Level 19 ft. from Land surface				Date 1987/11/10																												
PUMPING LEVEL (below land surface)		ft. after		hrs. pumping		g.p.m.																										
Well Head Completion		Pfliesz adapter mfr BAKER		Model 5PS67S4C1																												
Casing Protection		<input checked="" type="checkbox"/> 12 in. above grade		<input type="checkbox"/> At-grade(Environmental Wells and Borings ONLY)																												
Grouting Information		Well grouted? <input checked="" type="checkbox"/> Yes <input type="checkbox"/> No		Material From To (ft.) Amount(yds/bags)																												
		B																														
Nearest Known Source of Contamination		ft. direction E		type		SDF																										
Well disinfected upon completion?		<input checked="" type="checkbox"/> Yes <input type="checkbox"/> No																														
Pump <input type="checkbox"/> Not Installed		Date Installed Y																														
Mfr name AERMOTOR		Model A12-B-50		HP 0.5		Volts 230																										
Drop Pipe Length 36 ft.		Type S		Capacity 12 g.p.m.																												
Any not in use and not sealed well(s) on property?		<input type="checkbox"/> Yes <input type="checkbox"/> No																														
Was a variance granted from the MDH for this Well?		<input type="checkbox"/> Yes <input type="checkbox"/> No																														
USGS Quad Hope		Elevation 1173																														
Aquifer OGAL		Alt. Id.																														
Report Copy		Well CONTRACTOR CERTIFICATION		Lic. Or Reg. No. 81182																												
		License Business Name		Name of Driller BORN, R.																												

HE-01205-05 (Rev. 9/96)

Figure 1.

from the well logs, neither a digital nor a manual model can be constructed. A model is only as good as the information used to construct it. The wider the gaps in information, the less reliable the model will be. The same can be said about water levels. The greater the space between known points, the less reliable the representation will be. Along with proprietary data and maps supplied by Milestone Materials of Mathy Construction, 16 CWI well logs and the logs of three

monitoring wells constructed for this project were stratigraphically interpreted. Figure 2 is the stratigraphic column of the well shown in Figure 1. Stratigraphy in this case is the grouping of sedimentary formations into the hydrogeologic units described below. The stratigraphic data were then used to construct a three-dimensional model approximately 2.8 miles long and 1 mile wide (Figure 3). The monitoring wells, M-1, M-2 and M-3, are shown in addition to the CWI wells that are shown on Figure 3.

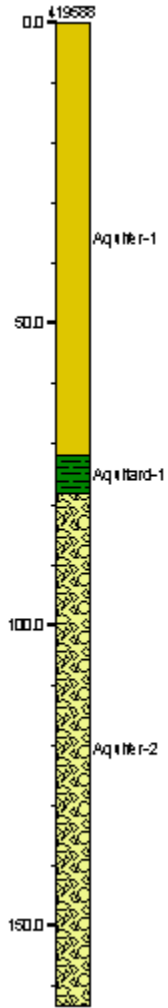

The numbers shown above the model in Figure 3 are Universal Transverse Mercator (UTM) locations in meters; each tick mark represents 1 kilometer. To assist in viewing the logs, the figure's vertical to horizontal exaggeration is 5:1. Most of the figures contained in this section will be shown with a vertical exaggeration of 5:1.

The well log analysis resulted in the following stratigraphic sequence, beginning at land surface:

- Overburden is sporadically found within the model area and is quite thin. Its presence does not exert much influence on the hydrogeologic conditions.
- A water table aquifer, hereafter referred to as Aquifer 1, which consists of sand and gravel and is open to atmospheric conditions.
- A confining layer mainly consisting of clay, hereafter referred to as the Aquitard. Aquitards restrict the movement of ground water in relation to aquifers. Not all aquitards are the same. The degree to which ground-water movement occurs varies considerably; a wide continuum of flow restriction exists. An aquitard can also leak due to thinning of material, cracks, or holes in it.
- A second, confined aquifer below the Aquitard, hereafter referred to as Aquifer 2. Lithologically, Aquifer 2 is the Galena Group, which is carbonate rock with karst features when the rock formation occurs close to the surface (Tipping and others, 2003).

Due to a lack of data, a third, confined aquifer was not included in this model. A second aquitard separates it from Aquifer 2. One irrigation well was constructed in the third aquifer. Its water surface was not used for water level computations because it was completed in the deeper, third aquifer and grouted to separate its screen from Aquifer 2. All the other CWI logs used in model construction were from domestic wells completed in Aquifer 2.

Figure 2.

Once data are entered into the model, the model calculates the top, bottom, and sides of each stratigraphic formation, smoothing the information between discrete known points. Because data are not available between the wells, the model is not a completely accurate representation of the layers; it is similar to hand-drawn cross-sections where lines are drawn between well points. Without data between each well, the area between the known points is interpolated and a line is drawn based on the interpolation.

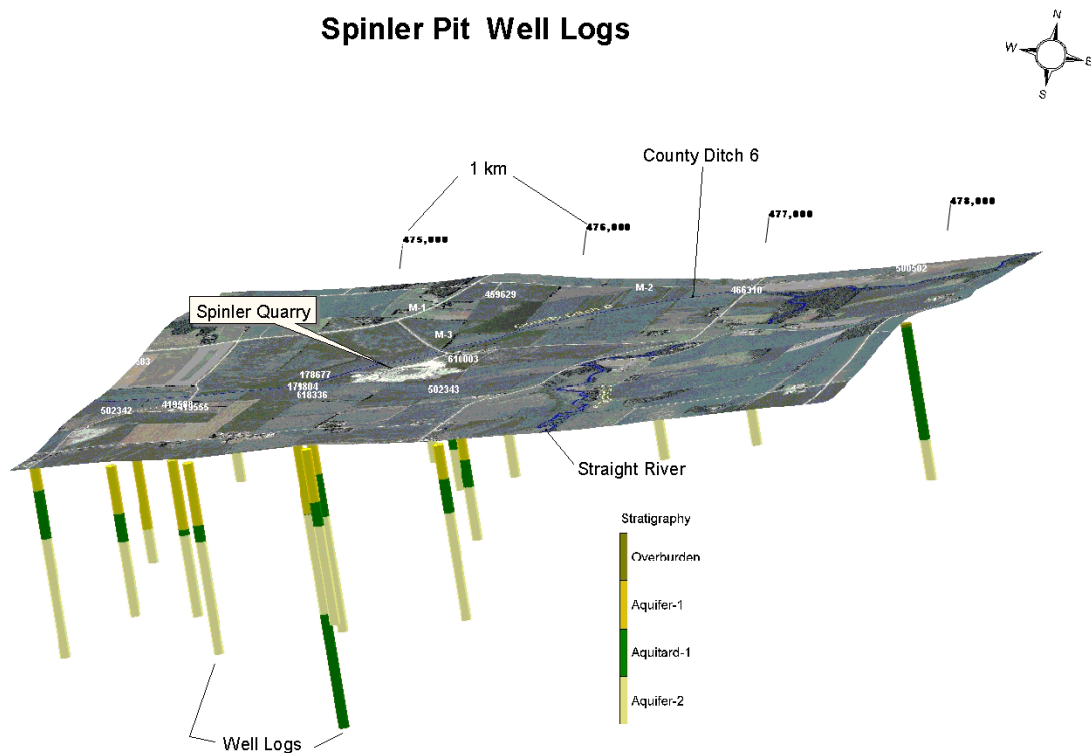

Figure 3.

The individual layers are created in grids. After the initial grid is created, a filtering function was employed to bring the pit and benches to their true elevations. The resulting filtered grids are reconstructed into the final three-dimensional solid model. Finally, the aerial photo of the site is draped onto the top layer to provide location and a feel for surface elevation.

Rockware 2004 also represents water surfaces in three-dimensional grids, which can be appended into the stratigraphic model along with the well logs. Each stratigraphic layer, well log, and water surface can be displayed or eliminated in the view to allow inspection of the layers and to determine where specific features and water levels reside three-dimensionally.

Figures 4a and 4b present the resulting solid three-dimensional model. Vertical to horizontal exaggeration is 1:1 and 5:1 for Figures 4a and 4b, respectively. Figure 4a is included to provide a comparison between real world conditions and figures with a vertical to horizontal exaggeration of 5:1. To aid in viewing the model results, all other figures in this section will have a vertical to horizontal exaggeration of 5:1.

As discussed above, all of the CWI logs used in the model were completed in Aquifer 2. All water surfaces reported in the logs were above the top of Aquifer 2 when the well was constructed. This is important because it shows that Aquifer 2 was a confined aquifer. When this occurs, the aquifer is considered to be artesian.

Spinler Quarry

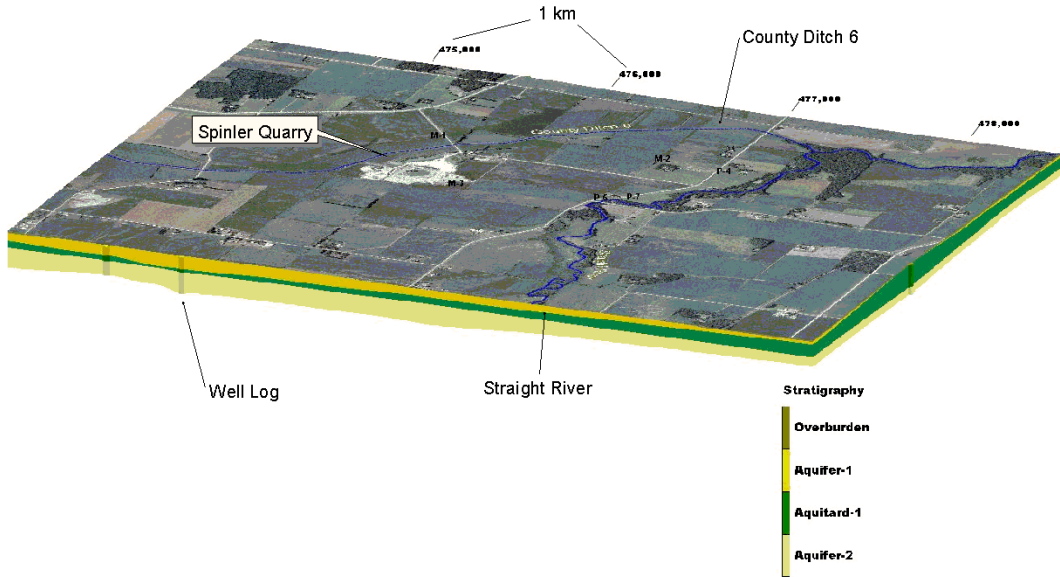

Figure 4a.

Spinler Quarry Transparent Stratigraphic Block

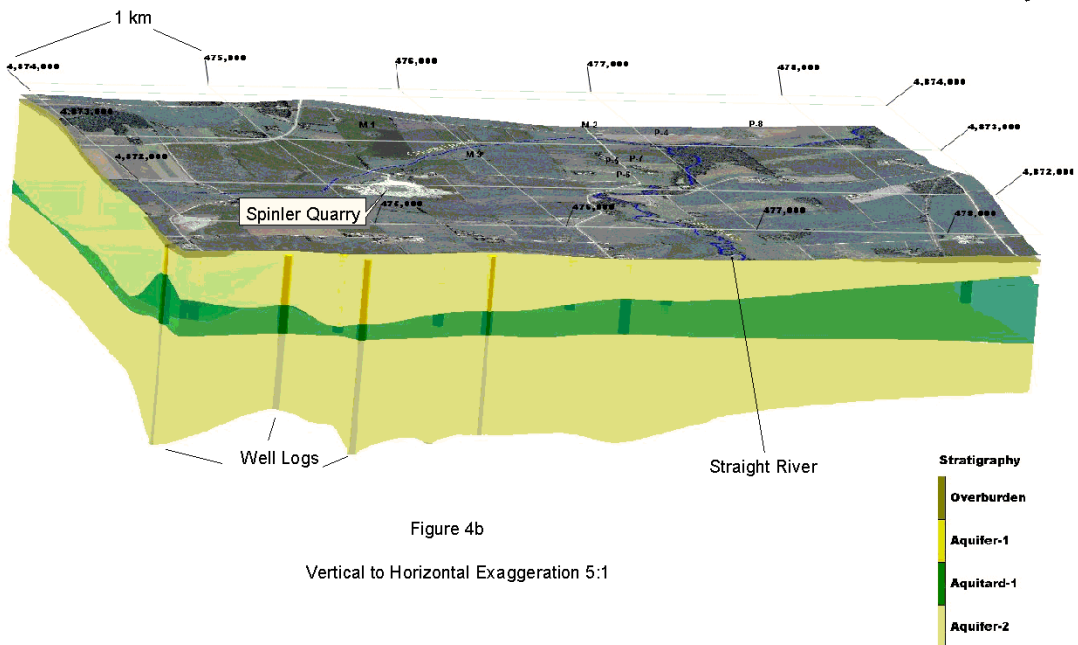

Figure 4b

Vertical to Horizontal Exaggeration 5:1

Figure 4b.

If the ground-water surface occurs at an elevation above the confined aquifer's top surface, the ground water is considered to be under artesian conditions. The ground water is under pressure that is greater than atmospheric pressure, which causes it to rise higher in the well than the top layer of the aquifer. The aquifer has an added component to its water height. The added component is either a higher elevation of the recharge zone or pressure that is being applied to the aquifer from the weight of the overlying earth materials. The height of a confined aquifer's water surface is termed its potentiometric surface.

Historical Water Level

To portray the historical water surface of Aquifer 2, the water surface elevations reported in the CWI well logs were combined into one database. This database is hereafter referred to as the prequarry potentiometric surface. All of the CWI wells were constructed prior to the gravel pit/quarry; most were in the late 1980s. Caution must be taken because the water levels in this database were not recorded the same day or even the same year. An important model assumption is that the confined water levels in Aquifer 2 were reasonably stable during the period of well construction. Though the water levels were not reported at the same time, it was decided to use the prequarry potentiometric surface for the following reasons:

- All the wells were completed in Aquifer 2 prior to quarry excavation.
- The aquifer was confined. In the absence of strenuous pumping, confined aquifer water levels generally remain more stable than water table aquifers because of their encasement and isolation from the land surface. The protection from the atmosphere results in a subdued response to precipitation.
- The resultant potentiometric surface is fairly horizontal, suggesting stable conditions.
- No other reliable data are obtainable; it is the best available representation. No recorded data are available for the prequarry Aquifer 1 water surface.

Figure 5 displays the assumed potentiometric surface (transparent, light blue) of prequarry Aquifer 2. Though water fills Aquifer 2 entirely, only the potentiometric surface is shown. To display the potentiometric surface, the overburden and Aquifer 1 layers are eliminated. Because the potentiometric surface is considerably above the Aquifer 2 and Aquitard tops, an upward (vertical) gradient from Aquifer 2 toward Aquifer 1 would occur whenever Aquifer 1 water levels drop below the Aquifer 2 potentiometric surface. If the Aquitard contains holes or is not effective in containing vertical movement, the Aquitard would have leaked, allowing ground water to move between the two aquifers.

Spinler Area Pre-Quarry Aquifer 2 Potentiometric Surface

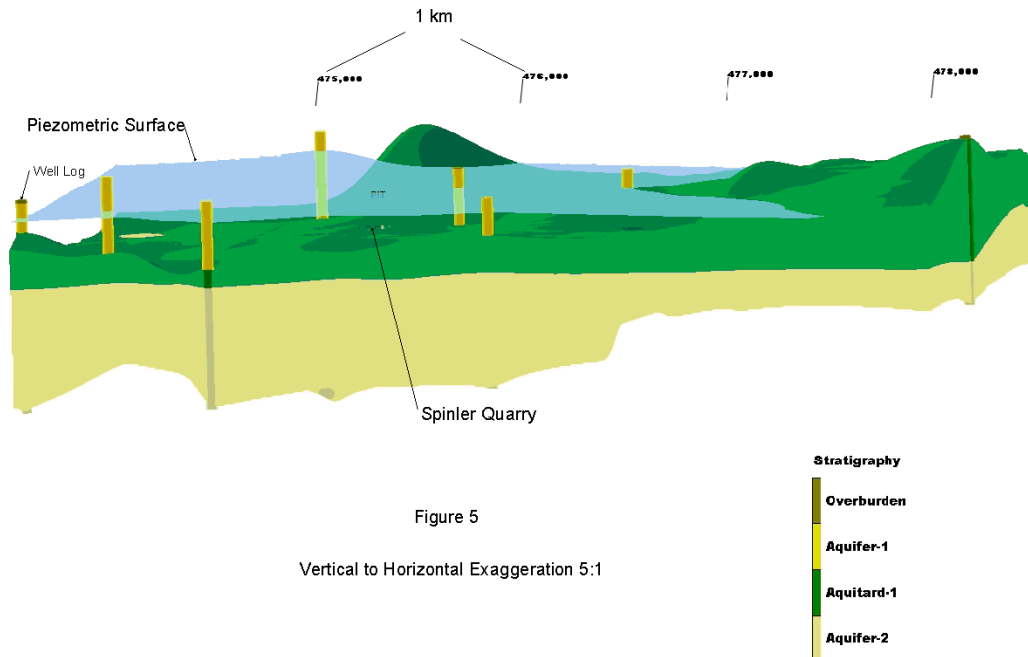

Figure 5

Vertical to Horizontal Exaggeration 5:1

To investigate the possibility of prequarry leakage, the overburden and Aquifer 1 layers were removed and the block was rotated to view the Aquifer top (Figure 6a). In addition to the pit, four holes in the Aquitard are shown in Figure 6a. Each hole was confirmed with well logs; the stratigraphy is interpolated between the individual wells. Therefore, the areal extent of the holes is unknown. The important factor is that the Aquitard is leaky and can move ground water between Aquifer 1 and Aquifer 2 depending on the difference in head, or elevation, between the Aquifer 1 water surface and Aquifer 2 potentiometric surface.

Figure 6b displays the potentiometric surface of prequarry Aquifer 2 with a change in the color pattern and without the stratigraphy being shown. The color pattern represents differences in elevation of the Aquifer 2 prequarry potentiometric surface. It allows identification of the horizontal ground-water gradient and flow (blue arrows). Based on the modeling, the potentiometric surface of prequarry Aquifer 2 sloped from west to east and in the western portion of the model from north to south. The highest prequarry Aquifer 2 potentiometric surface was near UTM 475,000. The holes in the Aquitard shown in Figure 6a are compatible and correspond with the higher potentiometric surface in Figure 6b.

Postquarry Water Levels

As discussed above, caution must be taken when viewing the water surface representations. Because no postquarry measurements are available for the area west of the pit and M-1, the true water surface west of M-1 may not be completely represented by the model's postquarry conditions. Water level measurements west of M-1 would allow for a more accurate depiction of quarrying impacts. In the active quarry, Aquifer 1 and the Aquitard have been removed.

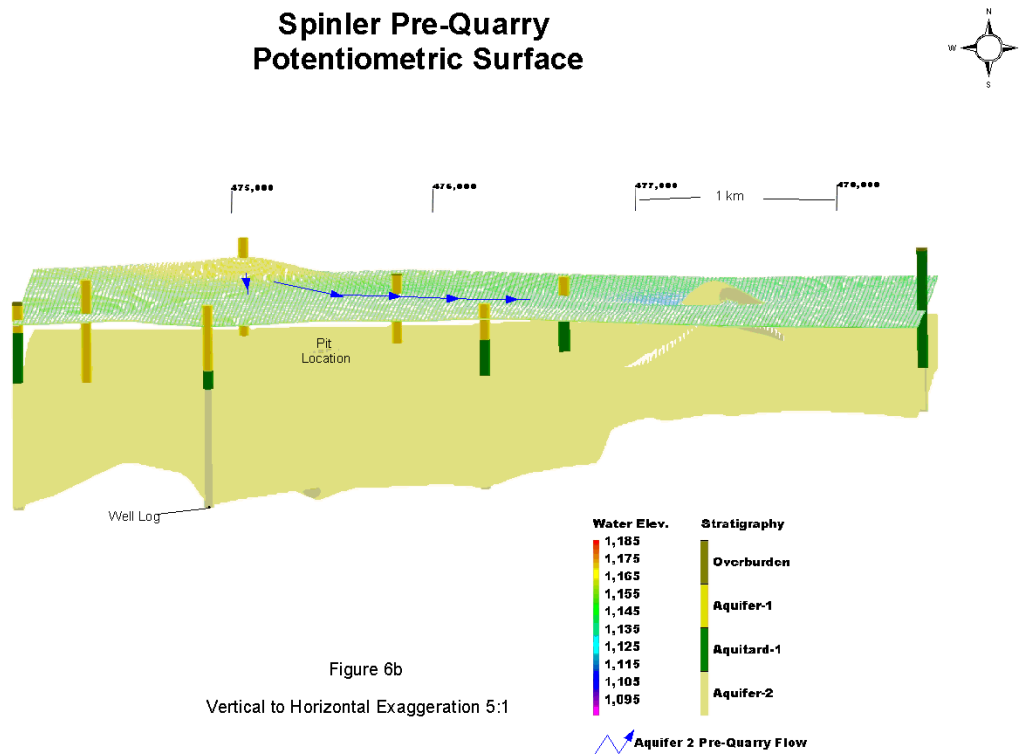
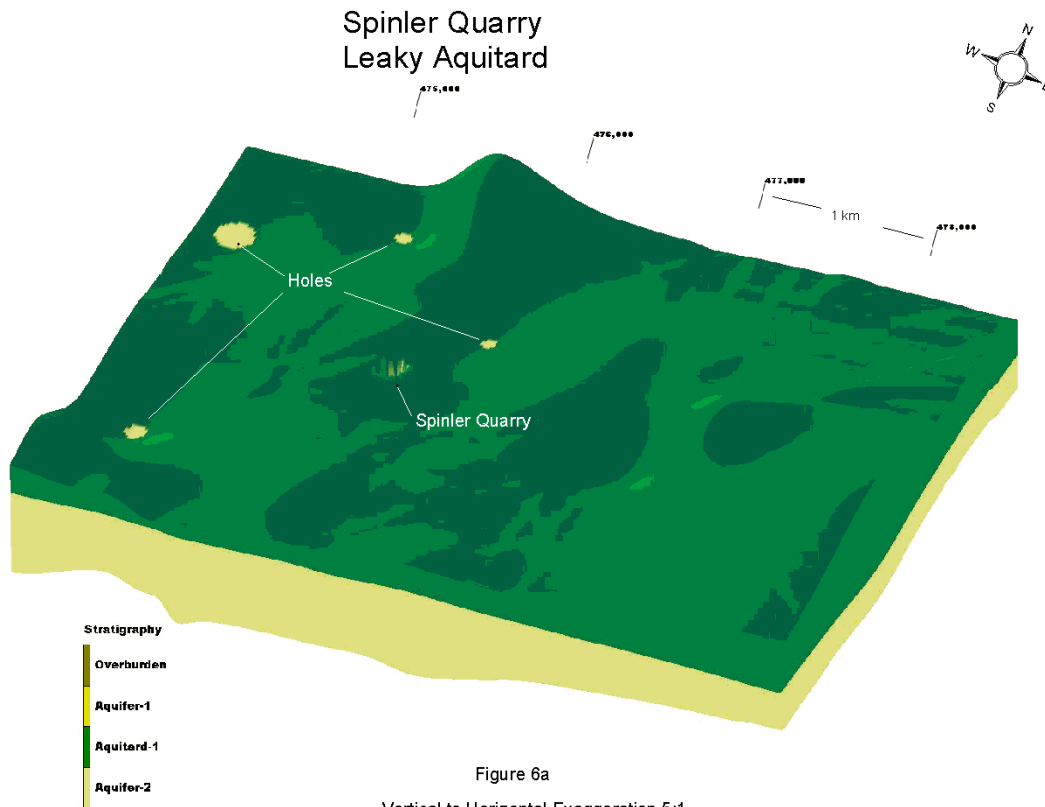

Quarrying operations have made a significant change in conditions. In addition to the puncture through the Aquitard, the pit is being dewatered to allow for removal of the Galena Formation (Aquifer 2). Figure 7 views the Aquitard bottom layer with Aquifer 2 eliminated; it looks upward from beneath the Aquitard. The magenta-colored surface is the pit water surface. It is being drawn down into Aquifer 2 through the puncture in the Aquitard.

Spinler Aquitard Bottom

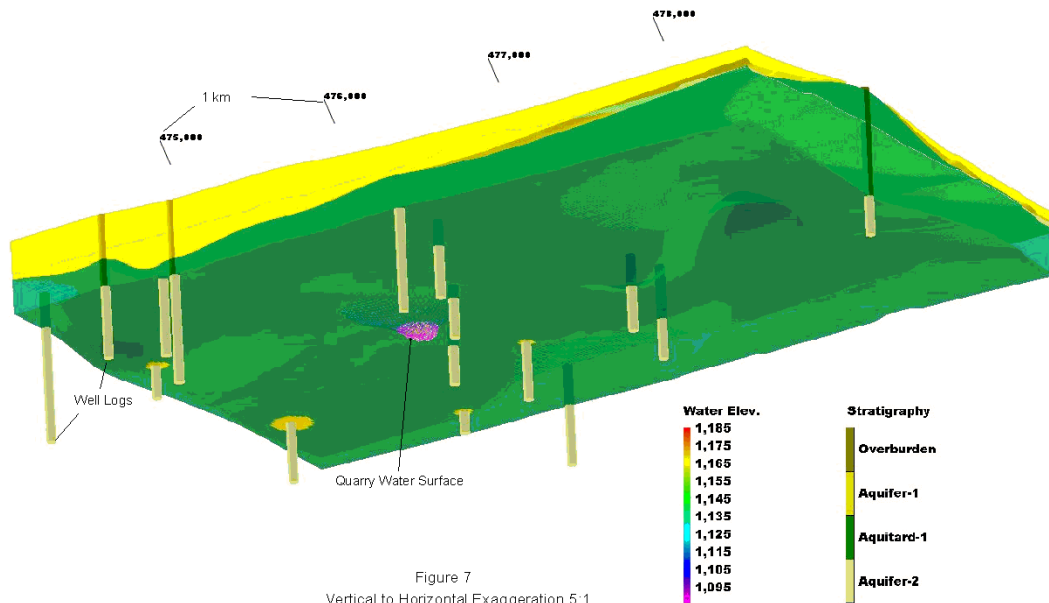

Figure 7
Vertical to Horizontal Exaggeration 5:1

Dewatering has significantly lowered the Aquifer 2 potentiometric surface. Figure 8a compares the prequarry surface shown in light blue, semitransparent, with the September 15, 2004 potentiometric, dark blue, wire mesh surface. As in Figure 6a, the Overburden and Aquifer 1 layers are not shown. Figure 8a demonstrates the dramatic change in areal extent and elevation of the Aquifer 2 potentiometric surface due to pit dewatering and puncture of the Aquitard.

Displaying the September 15, 2004 Aquifer 1 (dark blue mesh) and Aquifer 2 (solid lavender) with well logs only, Figure 8b shows the cone of depression surrounding the pit and the merging of Aquifer 1 and Aquifer 2 water surfaces due to dewatering. The red arrows represent the ground-water flow under these conditions and approximate the hydraulic gradient, or water surface slope, of Aquifer 1 west of the Straight River. Because the potentiometric surface of Aquifer 2 has been reduced, the hydraulic gradient of Aquifer 1 is steeply sloping toward the pit.

Though the September 2004 potentiometric surface has not yet been completely drawn below the top of Aquifer 2, dewatering has the potential of causing that condition. If Aquifer 2 water levels drop below the top of Aquifer 2, it will no longer be confined and mining of the ground water will begin. The aquifer can sustain irreversible damage such as land subsidence and aquifer compaction, particularly in a karst environment. The steeper hydraulic gradient, or slope of the water surface, can also induce erosion of the overlying sediments, adding silt into the conduit system and degrading water quality.

Spinler Pre-Quarry and Sept. 15 2004 Aquifer 2 Potentiometric Surfaces

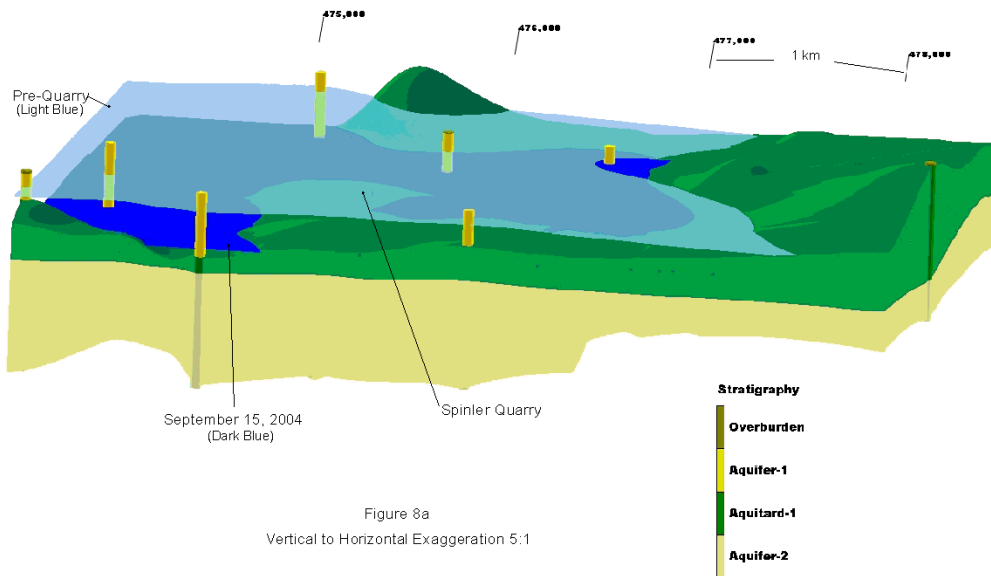

Figure 8a
Vertical to Horizontal Exaggeration 5:1

Spinler Aquifers 1 and 2 Sept. 15, 2004 Water Surfaces

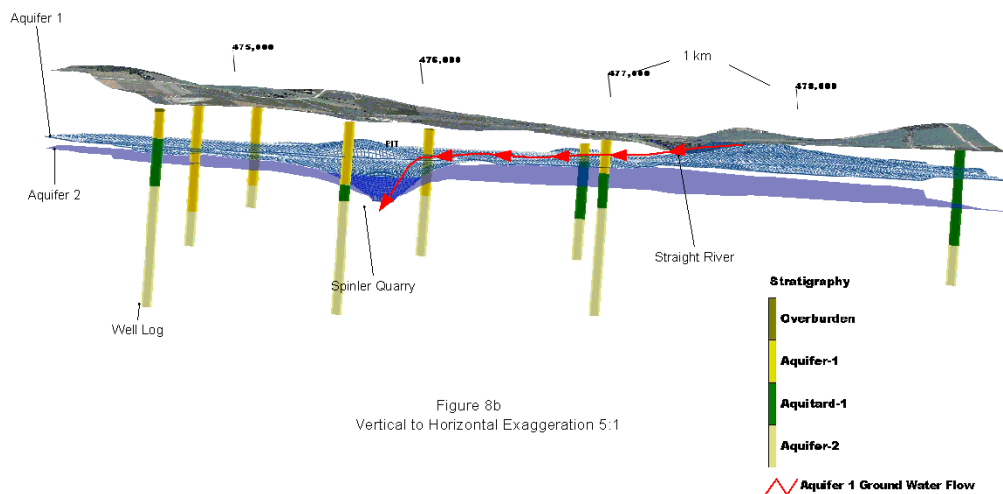
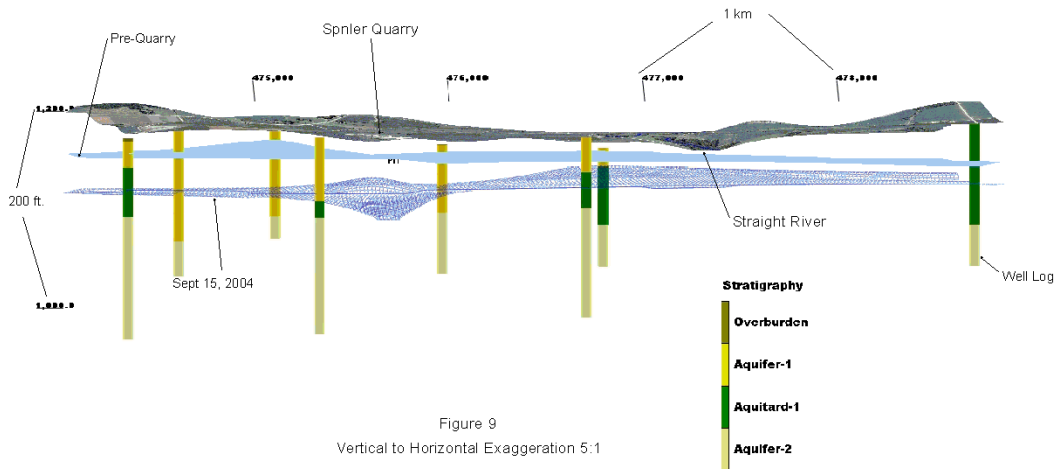
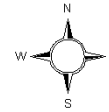

Figure 8b
Vertical to Horizontal Exaggeration 5:1

Dewatering may have already reduced the head potential of surrounding domestic wells. Figure 9 contains the prequarry (light blue) and postquarry (dark blue mesh) potentiometric surfaces. It appears that the pressure head loss due to dewatering is in the range of 30 feet in the western portion, which can reduce pump efficiency in a domestic well.

Spinler Sept. 15, 2004 and Pre-Quarry Aquifer 2 Potentiometric Surfaces



Although prequarry data are not available for Aquifer 1, comparing the present water surface of Aquifer 1 with the prequarry potentiometric surface of Aquifer 2 can provide insight into the prequarry water surface elevations of Aquifer 1. Figures 10a and 10b compare the prequarry potentiometric surface with the September 2004 Aquifer 1 water surface. The prequarry potentiometric surface is displayed in light blue (semitransparent in Figure 10a) and Aquifer 1 surface is shown in darker blue. Figure 10a is similar to Figure 8a in that the Overburden and Aquifer 1 layers are not shown. Like Figure 8b, Figure 10b displays the two water surfaces with the stratigraphic layers not shown.

In the western portion of the model, the prequarry potentiometric surface of Aquifer 2 is considerably higher than the September 2004 Aquifer 1 surface. The Aquitard is leaky and ground water in Aquifer 2 plays a role in Aquifer 1 levels when the potentiometric surface is above the Aquifer 1 water surface; therefore, it is likely that the water surface of Aquifer 1 would have at least mirrored the potentiometric surface of Aquifer 2 once they crossed. When the two surfaces meet, they will merge (Figure 10b). The merged surface would most likely be maintained at or above the potentiometric surface of Aquifer 2. Figure 11 (from Section 5, Spinler Quarry, of this report) suggests that the prequarry Aquifer 1 water surface is above the Aquifer 2 prequarry surface. Figure 11 was based on surface water and topographic contours to reconstruct the prequarry water table elevation of Aquifer 1. It is entirely possible that this was the case. The prequarry potentiometric surface is most likely the lowest elevation at which the prequarry water surface of Aquifer 1 existed. This means that the historic Aquifer 1 level would have been higher than existing conditions, and would have at the very least become horizontal once it reached the Straight River.

Figure 10b demonstrates that ground water flows (red arrows) down the hill in the eastern portion of Figure 10b and intersects the surface at or near the Straight River. This is also the case in Figure 11. Generally and in this geologic setting, ground water follows the surface contours and often intersects the ground surface at the base of a hill in the form of springs and surface flows. This scenario is supported by the fact that the clay Aquitard covers the hill (Figure 8a). East of the river, ground water will only be able to infiltrate to the Aquitard surface and then flow downhill on top of the Aquitard surface.

Spinler Pre-Quarry Aquifer 2 Potentiometric Surface and Aquifer 1 Sept 15, 2004 Water Surface

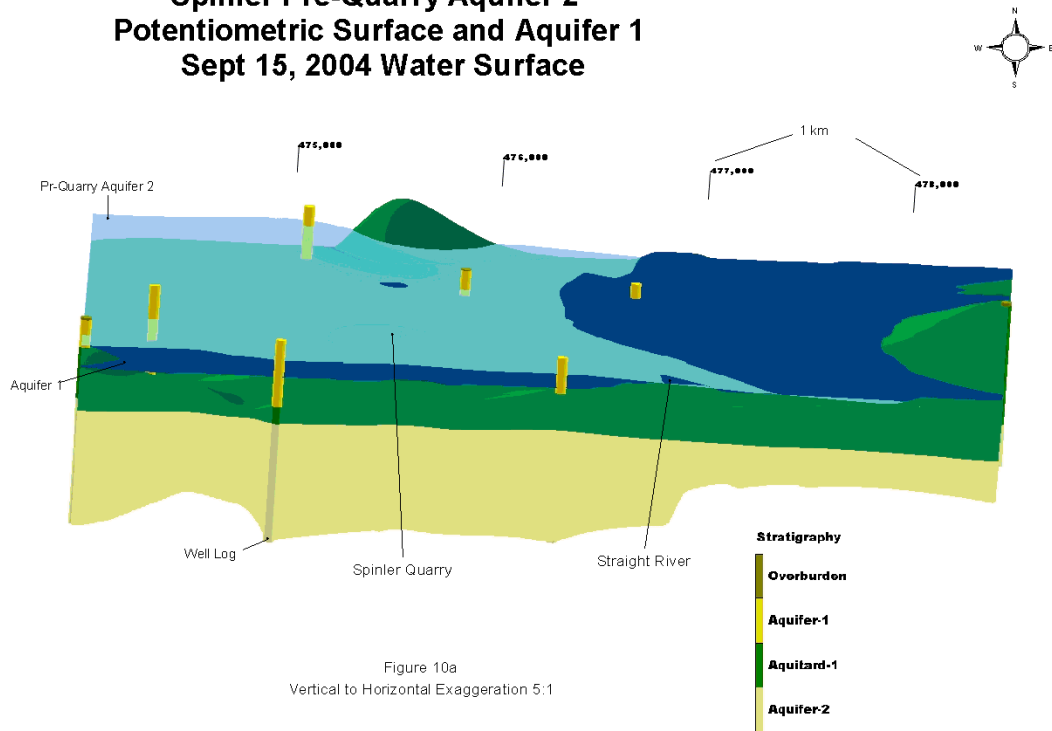

Figure 10a
Vertical to Horizontal Exaggeration 5:1

Spinler Pre-Quarry Aquifer 2 Potentiometric Surface and Sept 15, 2004 Aquifer 1 Water Surface

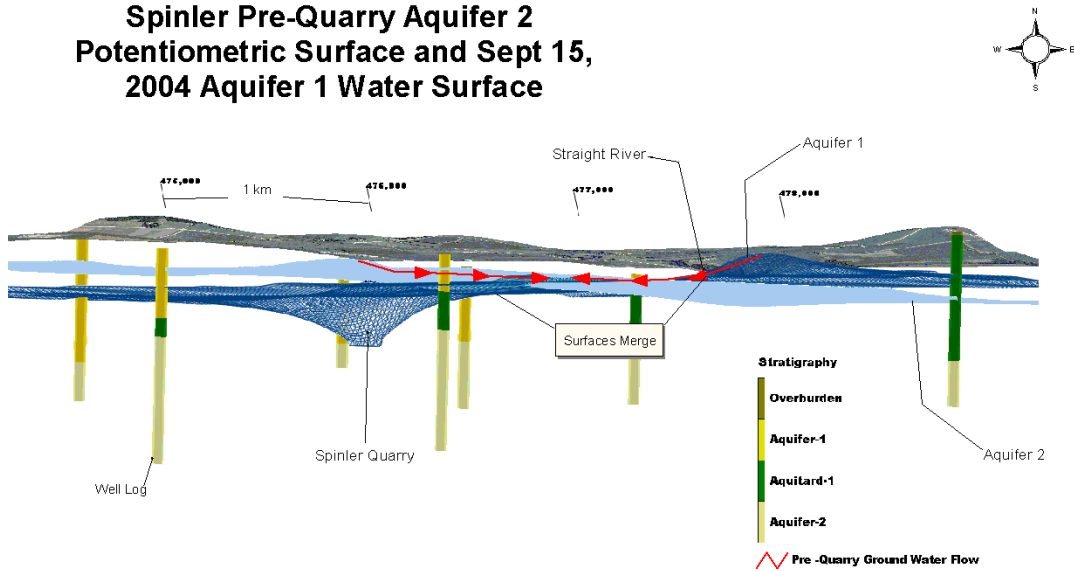

Figure 10b
Vertical to Horizontal Exaggeration 5:1

Spinler Pit Historic Water Level Upper Aquifer

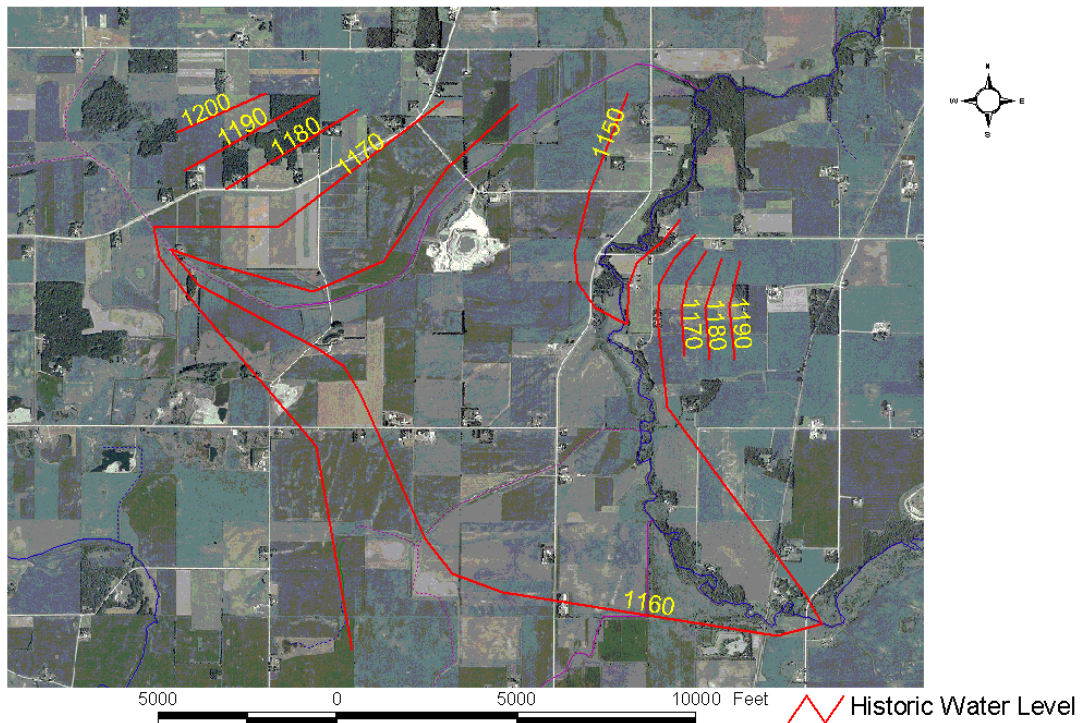

Figure 11.

Because the prequarry Aquifer 1 water surface was at a higher elevation, the hydraulic gradient near Straight River would have been flat instead of dipping toward the quarry, as is currently the case (See Figure 8b). The prequarry water surface of Aquifer 1 would have been similar to the dark blue surface in Figure 10b as it flowed downhill east of the stream. Prior to the quarry, once the Aquifer 1 surface encountered the Aquifer 2 surface, the Aquifer 1 water surface would be at or above the light blue surface west of the stream.

Figure 12 presents water level observations of Aquifer 1 (P1) and Aquifer 2 (M1) during 1999 and 2000. Before the pumping discontinued approximately August 8, 1999, the Aquifer 1 water level was above the potentiometric surface of Aquifer 2. During periods of pumping, ponds that reside within Aquifer 1 receive recharge from the pumped water, maintaining the Aquifer 1 elevation above the potentiometric surface of Aquifer 2. When the pumping discontinues, the water surfaces cross and the Aquifer 2 potentiometric surface lies above the Aquifer 1 water surface until pumping begins again around May 15, 2000. The graph identifies that dewatering of the quarry is having a greater impact on Aquifer 2 levels and that Aquifer 2 has an important influence on Aquifer 1 water levels when pumping is not a factor. It supports the prior assessment that the prequarry water surface of Aquifer 1 was at least equal to the potentiometric surface of Aquifer 2. It also indicates prequarry hydraulic gradient of Aquifer 1 was at least horizontal west of the Straight River, mirroring the Aquifer 2 potentiometric surface.

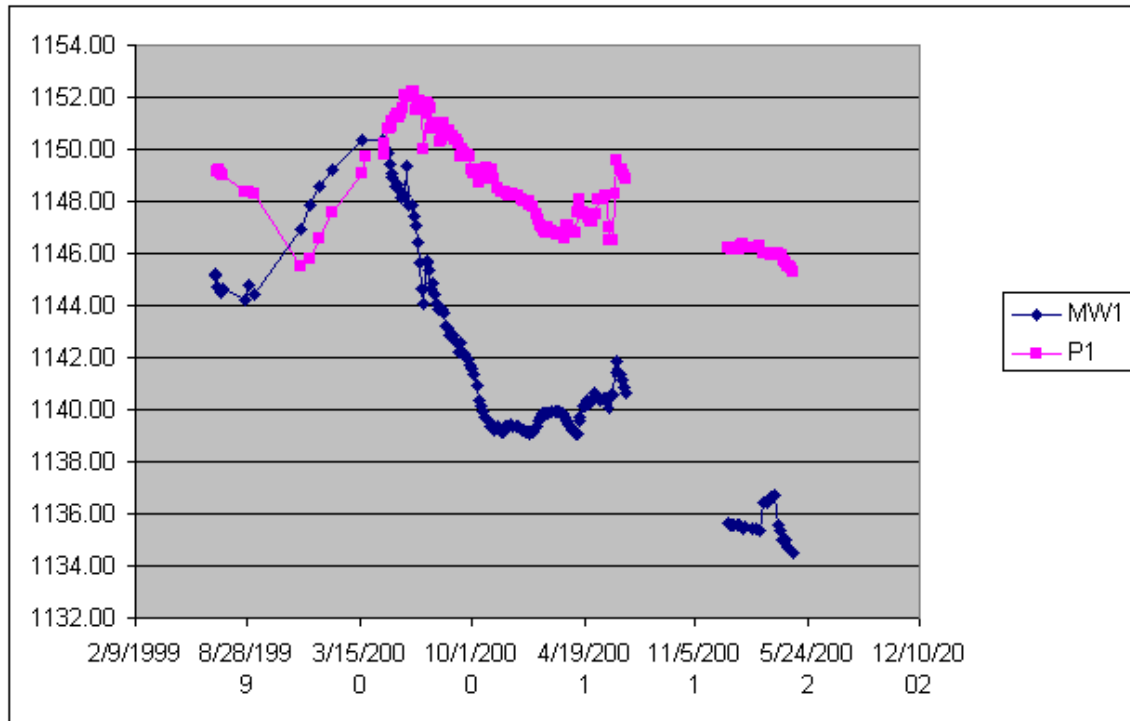

Figure 12.

Figure 13 presents the prequarry potentiometric surface in light blue, the June 1, 2005 Aquifer 1 water surface in lavender, and the June 1 Aquifer 2 surface in medium blue. To separate the three water surfaces, Figure 12 has a vertical to horizontal exaggeration of 10 to 1. Remember that postquarry observed water levels are not available west of M-1 when viewing Figure 12.

The significance of Figure 13 is the obvious melding of water surfaces near the Straight River and the horizontal gradient of the ground-water surface west of the Straight River. Water levels within the pit area have rebounded to prequarry conditions. This is important because, if the pit is discontinued, water levels should rebound to their historic conditions.

Since the prequarry gradient at the Straight River was at least horizontal, the river would have been gaining flow from the ground water east of the stream. Because no historic stream discharge data are available, this assumption cannot be confirmed. Yet, it is more likely that the stream reach was a gaining reach rather than a losing reach, which it may be under present-day conditions. In other words, the stream was receiving ground-water flow from east of the river, which contributed to the stream's discharge or flow. Now that the hydraulic gradient west of the stream has been changed from horizontal to dipping toward the pit, the stream is no longer gaining flow and may be losing flow to the ground-water system west of the stream.

Spinler Quarry Pre-Quarry Aquifer 2 Potentiometric, and June 1, 2005 Aquifer 1 and Aquifer 2 Surfaces

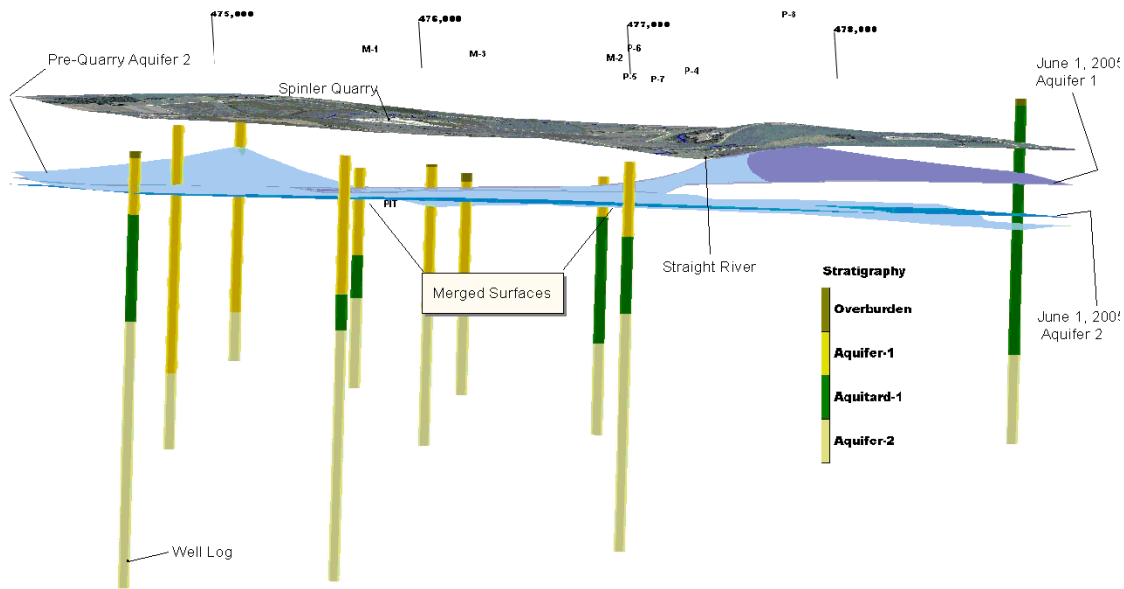

Figure 13. (vertical exaggeration 10:1)

Summary

A summary of insights and observations facilitated by the three-dimensional model efforts are the following:

- One confined aquifer (Aquifer 2) and one unconfined aquifer (Aquifer 1) are separated by a clay aquitard.
- The Aquitard is leaky and Aquifer 2 is under artesian conditions. Depending on the height of the Aquifer 1 water surface, Aquifer 1 and Aquifer 2 supply water to each other. If Aquifer 1 is above the Aquifer 2 potentiometric surface, then Aquifer 2 receives water from Aquifer 1. If the case is reversed, the Aquifer 2 potentiometric surface controls Aquifer 1 water levels west of Straight River.
- The quarry has penetrated the two aquifers and Aquitard.
- Dewatering of the quarry has drawn the water surfaces of both aquifers down, causing a lowering of Aquifer 2's potentiometric surface.
- Domestic wells are constructed in Aquifer 2.
- Lowering of the potentiometric surface may have caused a reduction in domestic well efficiency.
- Prior to the quarry, the Straight River was gaining water from the ground water. Since dewatering has occurred, the stream no longer gains ground water and may be losing to the ground water because of the change in the hydraulic gradient of both aquifers' water surfaces west of the stream.
- Historic ground-water levels can be restored once pumping ceases. During periods of inactivity within the quarry, pumping should cease to allow restoration of domestic supply levels and to return ground-water supplies to the Straight River. If further

- monitoring of the quarry operations continues, it is recommended to periodically obtain water levels of surrounding domestic wells, particularly west of the quarry.
- A model is only as good as the information used to build the model. Well logs and historic water level measurements are the most important input data. Little funding currently exists to maintain and enhance these two crucial databases; expanded support for basic information is needed so that we can provide answers to questions being asked about the roles aggregate mining and rock quarrying play in our water resources.

APPENDIX 3. GLOSSARY

Alluvial Pertaining to or consisting of alluvium, deposits made by streams on river beds, floodplains, and alluvial fans.

Aquifer A layer of rock or unconsolidated material that yields water in usable quantities to a well or spring.

Aquitard A layer of rock or unconsolidated material having very low hydraulic conductivity that restricts movement of water into an aquifer.

Aggregate Any of several hard, inert materials, such as sand, gravel, crushed stone, or combinations, used for mixing in various-sized fragments with a cementing or bituminous material to form concrete, mortar, asphalt, or plaster; it may also be used alone as in railroad ballast or graded fill. Fine aggregate is the material that will pass a 0.25-inch screen, and coarse aggregate is the material that will not pass a 0.25-inch screen.

Bedrock aggregate Crushed rock (hard, solid bedrock) used as aggregate.

Carbonate rock A rock comprising more than 50% (by weight) calcite or dolomite or mixtures of the two, such as limestone or dolostone (dolomitic rock).

Cobble A rock fragment between 2.5 inches (64 mm) and 10 inches (256 mm) in diameter.

Conduit Relatively large solution voids, including enlarged fissures and tubular tunnels; in some usage the term is restricted to voids that are filled with water.

Cone of depression A depression in the potentiometric surface of a body of water, which has the shape of an inverted cone and develops around a well from which water is being withdrawn.

Dolostone A carbonate sedimentary rock that contains more than 90% of the mineral dolomite and less than 10% of the mineral calcite. Dolostone is commonly referred to as dolomite, dolomite rock, or dolomitic rock.

Gravel General term for sediment consisting of pebbles, cobbles, and boulders. Commercially, the term gravel indicates a sedimentary deposit consisting of 20% or more pebbles, cobbles, and boulders, admixed and interstratified with sand.

Hydraulic conductivity A measurement of the capacity of geologic materials to transmit water commonly expressed in units of gallons per day per square foot.

Karst An area of limestone or other highly soluble rock, in which the landforms are of dominantly solutional origin and in which the drainage is underground in solutionally enlarged fissures and conduits (caves). Karst processes significantly change the flow, transport, and storage behavior of ground water in such areas; turbulent flow in conduits is a characteristic feature of karst systems even in areas where no surface features are present.

Limestone. A carbonate sedimentary rock containing more than 95% of the mineral calcite and less than 5% of the mineral dolomite. Carbonate rocks containing between 5% and 50% dolomite and 50% to 95% calcite are referred to as dolomitic limestones.

Outwash Sand and gravel transported or “washed out” from a glacier by meltwater streams and deposited in front of or beyond the terminal moraine or the margin of an active glacier or ice sheet.

Pebble A rock fragment between 0.8 inch (2 mm) and 2.5 inches (64 mm) in diameter.

Piracy The process in which flow from a surface or subsurface stream is diverted into a different flow path by the physical change of the stream’s course.

Pit (commercial sense) An opening in the land surface from which unconsolidated rock materials are excavated for sale or commercial use.

Potentiometric map A subsurface contour map showing the elevation of a potentiometric surface.

Potentiometric or piezometric surface An imaginary surface representing the total head of ground water and defined by the level to which water will rise in a well. The water table is a particular potentiometric surface.

Quarry A mine or opening in the land surface from which consolidated rock materials are excavated for sale or commercial use.

Sand Grains of rocks or minerals that range from 0.002 inch (0.062 mm) to 0.8 inch (2 mm) in diameter. Sand grains are divided into five categories, depending on grain size: very coarse 1–2 mm; coarse 0.5–1 mm; medium 0.25–0.5 mm; fine 0.25–0.125 mm; very fine 0.125–0.062 mm.

Sedimentary rock A rock resulting from the consolidation of loose sediment that has accumulated in layers

Shale A sedimentary rock consisting of thinly laminated and compressed clay. It has a low specific gravity and high absorption. Shale is a spall material that is highly deleterious to concrete.

Sinkhole A small to medium sized closed depression formed by slow, concentrated solutional removal of rock in an area, from the surface downward or by the collapse of overlying rock into a cave or chamber beneath.

Sorting A term used to indicate the amount of uniformity in particle size of a sediment; a well-sorted sediment contains particles of similar size.

Spring Any natural discharge of water from rock or soil onto the surface of the land or into a body of surface water.

Stream sink A well-defined point of water loss ranging in size and shape from a cave entrance to narrow cracks in bedrock streambeds.

Water table The upper surface or elevation of the ground water within the aquifer that is closest to the ground surface.

APPENDIX 4. LIST OF REFERENCES

- Alexander, E.C., Jr., Green, J.A., Alexander, S.C., and Spong, R.C., 1995, Springsheds (Plate 9) *in* Geologic Atlas of Fillmore County, Minnesota: Minnesota Department of Natural Resources County Atlas Series C-8, Part B.
- Bolen, W.P., 2004, U.S. Geological Survey Mineral Commodity Summaries, January 2004.
- Drew, D. and Hötzl, H., eds., 1999, Karst hydrology and human activities: impacts, consequences and implications: Brookfield, Vt., A.A. Balkema Publishers, 322 p.
- Ewell, M., 2003, Mining and quarrying trends, USGS Mineral Survey.
- Fay, S.J. and Alexander, E.C., Jr., 1994, Groundwater dye trace report: Watson-Warrington Group detention structure, section 17, township 112 north, range 15 west, Featherstone Township, Goodhue County, Minnesota, report to Goodhue County Soil and Water Conservation District, February 1994: University of Minnesota Department of Geology and Geophysics, 25 p., 3 appendices.
- Green, J.A., Pavlish, J.A., Leete, J.H., and Alexander, E.C., Jr., 2003, Quarrying impacts on groundwater flow paths, *in* Proceedings of the ninth multidisciplinary conference on sinkholes and the engineering and environmental impacts of karst, Huntsville, Ala., Sept. 6-10, 2003: Reston, Va., American Society of Civil Engineers.
- Heath, R.C., 1984, Basic ground-water hydrology: U.S. Geological Survey Water-Supply Paper 2220.
- Lowe, D. and Waltham, T., 1995, Dictionary of karst and caves, No. 6: British Cave Research Association.
- Monroe, W.H., 1970, Glossary of karst terminology: U.S. Geological Survey Water-Supply Paper 1899-K.
- Mossler, J.H., 1995, Bedrock geology (Plate 2) *in* Geologic Atlas of Fillmore County, Minnesota: Minnesota Geological Survey County Atlas Series C-8, Part A.
- Nelson, S.L., Oberhelman, M.W., and Olson, D.J., 1990, Inventory of industrial mineral pits and quarries in Minnesota: Minnesota Department of Natural Resources, Division of Minerals, Report 282, 2 vol.
- Runkel, A.C., Tipping, R.G., Alexander, E.C., Jr., Green, J.A., Mossler, J.H., and Alexander, S.C., 2003, Hydrogeology of the Paleozoic bedrock in southeastern Minnesota: Minnesota Geological Survey, Report of Investigations 61, 105 p., 2 pls.
- Southwick, D.L., Jouseau, M., Meyer, G.N., Mossler, J.H., and Wahl, T.E., 2000, Aggregate resources inventory of the seven-county metropolitan area, Minnesota: Minnesota Geological Survey Information Circular 46, 91 p.
- U.S. Geological Survey, 1974, Water resources of the Cannon River watershed, southeastern Minnesota: Hydrologic Investigations HA-522.
- U.S. Geological Survey, 1999, Fact Sheet 14-97.